

SIYI

# UniRC 7 Series Handheld Ground Station User Manual



SIYI Technology (Shenzhen) Co., Ltd.

[siyi.biz/en](http://siyi.biz/en)

# SIYI



Thank you for purchasing the products of SIYI Technology.

UniRC 7 is the high-performance professional handheld ground station built for unmanned aerial vehicles, vehicles, ships, etc. It integrates high-performance points and innovative designs such as 2.4G/5G dual frequency, 40KM remote control distance, 4K 30FPS decoding performance, transmission code rate as high as 65Mbps, AES encryption, 1600 nit 1080P HD highlight 7-inch screen, unique design of small rocker, six-gear flight mode key and quick-release belly support, with excellent performance and innovative design, it provides the ultimate experience for UAV control and promotes the industry control technology to a new height.

Considering flight safety and in order to bring you a good product experience, please consult the user manual carefully before installing the machine. This manual can help you solve most of your usage questions. You can also visit the product-related pages of SIYI Technology's official website ([www.siyi.biz](http://www.siyi.biz)), call SIYI Technology's official after-sales service center (400-838-2918) or send an email to the [support@siyi.biz](mailto:support@siyi.biz) to directly consult SIYI Technology Engineers about product-related knowledge and feedback product problems.

# SIYI

Contact Us: **SIYI Official Website** (<https://siyi.biz/en>)

SIYI User Group - Facebook	
Facebook	
LinkedIn	
YouTube	

## Manual Version Update Record

Version Number	Update Date	Update Content
1.0	2024.11	Initial version
1.1	2024.11	Added some parameters and corrected some text errors
1.2	2025.03	Some of the images have been replaced Modify certain known issues.
1.3	2025.04	Delete the incorrect information
1.4	2025.5	1. Added battery maintenance instructions 2. Added LAN port instructions 3. Modified some known issues
1.5	2025.8	Modify certain known issues.
1.6	2025.10	1. Added solutions for abnormal firmware upgrade scenarios. 2. Expanded firmware upgrade-related content. 3. Fixed known issues. 4. New indicator light status definitions. 5. Added description of multiple links content.
1.7	2026.03	1. Added detailed content for image transmission firmware upgrade.
1.8	2026.04	1. Added instructions for upgrading the video transmission firmware. 2. Updated the SDK documentation. 3. Added a power supply warning note to the safety section.

## Directory

Reading Instructions .....	8
Symbols and Icons .....	8
Safety .....	8
Chapter 1 Product Overview .....	13
1.1 Product Features .....	13
1.2 Component Description .....	17
1.2.1 Product Overview .....	17
1.2.2 Interface Definitions .....	18
1.2.3 Button, Switch Types, and Channel Definitions .....	19
1.3 Technical Specifications .....	21
1.4 Item List .....	24
1.5 Status Indicator Definitions .....	25
1.5.1 Ground Unit Indicator Definitions .....	25
1.5.2 Air Unit Indicator Definitions .....	26
1.5.3 Dual-Control Mode Indicator Definitions .....	27
Chapter 2 Before Use .....	28
2.1 Ground Unit .....	28
2.1.1 Power On and Off .....	28
2.1.2 Charging .....	29
2.1.3 Charging Indicator Definitions .....	30
2.1.4 Switching System Language .....	30
2.2 Important Instructions for Enhancing Communication Range and Video Smoothness ....	35
2.2.1 Usage Precautions .....	35
2.2.2 Installation and Placement of the Standard Omnidirectional Antenna on the Ground Unit .....	35
2.2.3 Installation and Placement of the Standard Omnidirectional Antenna on the Air Unit .....	36
2.2.4 Necessary Information Required Before Requesting Factory .....	40
Chapter 3 UniGCS Application .....	43
3.1 Flight Interface and Map Interface .....	43
3.2 Gimbal Settings .....	44
3.2.1 Connecting the Gimbal .....	44
3.3 Remote Controller Settings .....	45
3.3.1 Joystick Modes .....	45
3.3.2 Remote Controller Calibration .....	46
3.3.3 Data Transmission Settings .....	50
3.3.4 Channel Settings .....	53
3.3.5 Link Status .....	57
3.3.6 Button and Dial Settings .....	59
3.3.7 Receiver Settings .....	61
3.3.8 Failsafe Settings .....	61
3.3.9 System Settings .....	64

# SIYI

3.3.10 Multiple links .....	71
3.3.11 Video Transmission Settings .....	77
3.4 Device Information .....	83
Chapter 4 Telemetry Data Transmission .....	84
4.1 Communication with Android Ground Station via UART .....	85
4.1.1 BoYing “XUAV” .....	85
4.2 Communication with Android Ground Station via Bluetooth .....	87
4.2.1 QGroundControl .....	87
4.2.2 Mission Planner .....	90
4.2.3 JiYi “AgriFly Assistant” .....	90
4.3 Communication with Android Ground Station via UDP .....	92
4.3.1 QGroundControl .....	92
4.3.2 Mission Planner .....	94
4.3.3 VGCS Ground Station .....	95
4.4 Communication with Windows Ground Station via Ground Unit Type-C Upgrade Port ..	96
4.4.1 QGroundControl .....	96
4.4.2 Mission Planner .....	98
4.5 Communication with Windows Ground Station via UDP through Ground Unit WiFi	
Hotspot .....	99
4.5.1 QGroundControl .....	99
4.5.2 Mission Planner .....	101
4.6 Troubleshooting Data Transmission Connection Failures .....	102
Chapter 5 Image Transmission .....	104
5.1 SIYI Gimbal Cameras (Optical Pods) AI Tracking via SIYI AI Tracking Module over	
SIYI Link .....	104
5.2 Control of SIYI Optical Pods (Gimbal Cameras) via SIYI Link Using UniGCS or SIYI	
QGC Android Applications .....	106
5.2.1 Preparation .....	107
5.2.2 Gimbal pitch and yaw .....	109
5.2.3 Zoom Control .....	110
5.2.4 Photo and Video Recording .....	110
5.3 SIYI Link Control of SIYI Pods (Gimbal Cameras) via SIYI QGC (Windows) Software	
111 .....	111
5.3.1 Preparation .....	111
5.3.2 Gimbal Pitch and Yaw control .....	114
5.3.3 Zoom and Focus .....	114
5.3.4 Photo and Video Capture .....	115
5.4 Connecting SIYI Link to Third-Party IP Cameras .....	115
5.5 Integrating SIYI Link with HDMI Cameras .....	116
5.6 Integrating SIYI Link with Dual Video Streams .....	117
5.6.1 Connecting Two SIYI Cameras or Two HDMI Input Modules .....	117
5.6.2 Connecting Two Third-Party IP Cameras or Optical Pods .....	117
5.7 Common Device Parameters .....	118
5.8 Troubleshooting Video Feed Display Issues .....	120
5.9 Outputting Video from the Ground Unit to Other Devices .....	121

# SIYI

5.9.1 Output via the Ground Unit's HDMI Port .....	121
5.9.2 Output via Ground Unit Wi-Fi Hotspot Sharing .....	122
5.9.3 Outputting Video via Ethernet Port .....	123
Chapter 6 SDK Communication Protocol .....	128
6.1 Protocol Format Description .....	128
6.2 Communication Commands .....	128
6.2.1 0x40: Get Remote Controller Hardware ID .....	128
6.2.2 0x16: Get System Settings .....	129
6.2.3 0x17: System Settings .....	130
6.2.4 0x42: Remote Control Channel Data .....	131
6.2.5 0x43: Retrieve Remote Link Information .....	132
6.2.6 0x44: Retrieve Video Link Information .....	133
6.2.7 0x47: Retrieve Firmware Version Number .....	134
6.2.8 0x48: Retrieve All Channel Mappings .....	135
6.2.9 0x49: Retrieve Channel Mapping .....	136
6.2.10 0x4A: Set Channel Mapping .....	137
6.2.11 0x4B: Retrieve All Channel Reversals .....	138
6.2.12 0x4C: Retrieve Channel Reversal .....	138
6.2.13 0x4D: Set Channel Reversal .....	139
6.2.14 0x4E: Get multi-device interconnection status .....	139
6.2.15 0x4F: Get system status (actively sent when there is a warning) .....	140
6.3 Communication Interfaces .....	142
6.4 CRC16 Verification code .....	143
Chapter 7 Android System .....	145
7.1 Application Download .....	145
7.2 How to Import and Install Applications .....	146
7.2.1 Import and Install via TF Card .....	146
7.2.2 Import and Install via USB Drive .....	146
7.2.3 Import and Install via Type-C File Transfer .....	146
7.3 Check Android Firmware Version .....	149
Chapter 8 SIYI Tuning Assistant .....	151
8.1 Firmware Upgrade .....	152
8.2 Image Transmission Firmware Upgrade .....	155
Chapter 9 After Sales and Warranty .....	157

## Reading Instructions

### Symbols and Icons

When reading the user manual, please pay special attention to the following icons and their corresponding meanings:

 **DANGER:** Indicates operations that are very likely to cause personal injury.

 **WARNING:** Indicates operations that may potentially cause personal injury.

 **CAUTION:** Indicates operations that may result in unnecessary property damage due to improper handling.

 Prohibited    Mandatory    Caution

### Safety

The UniRC 7 Handheld Ground Station is designed and manufactured for professional applications. It has undergone all necessary calibrations before leaving the factory. Do not disassemble or modify its structure without authorization. The UniRC 7 features a precision-engineered

# SIYI

design, and operators are expected to possess basic technical skills—handle with care.

SIYI Technology bears no responsibility for any damage to the product, economic loss, or personal injury caused by improper or irresponsible use. Minors must be supervised by a professional when using this product.

SIYI products are designed for commercial use only and are strictly prohibited from being used for any military purposes. Disassembly or modification of this product without SIYI Technology's permission is not allowed.

To ensure flight safety and to fully utilize the features of this product, please pay special attention to the following safety precautions:

 Do not operate SIYI products to control aircraft, vehicles, or models in crowded areas (such as squares and parks), locations with numerous obstacles (such as streets and parking lots), areas with strong magnetic fields or sources of signal interference (such as high-voltage power lines, railway lines, or radar stations), or any other environments that may lead to unnecessary economic loss or personal injury.

 During operation, never cover the ground unit antenna or obstruct signal transmission in any way.

# SIYI

 The tip of the standard omnidirectional antenna on the ground unit is the weakest point for signal transmission. During operation, avoid pointing it directly at your aircraft, vehicle, or model.

 Do not operate aircraft, vehicles, or models using SIYI products while fatigued, under the influence of alcohol, or experiencing physical discomfort.

 Unless specially authorized for such operations, do not use SIYI products to control aircraft, vehicles, or models in rainy weather, at night, or in strong wind conditions.

 Do not power off the ground unit while the engine or motor on your aircraft, vehicle, or model is still running.

 For flight safety, always keep the aircraft within your line of sight during operation.

 If stored for a long time, the battery must be charged and discharged once every two months.

 During operation, make sure to return to the main page from the system settings page.

 Before starting the operation, check the battery level of the ground

# SIYI

unit and the power voltage of the air unit.

 After completing the operation, power off the air unit first, then the ground unit.

 Before configuring ground unit parameters, ensure the engine or motor is powered off to prevent accidental activation.

 Before operation, be sure to pre-set the fail-safe function on the ground unit or in the ground control software.

 Before operation, power on the ground unit and keep the throttle at the lowest position, then power the air unit.

 When assembling, avoid placing the air unit too close to the GPS module to prevent interference. A distance of more than 20 cm between the air unit and the GPS module is recommended.

 When using a DC power supply to power the air unit, do not increase the supply voltage while the device is powered on, as this may cause equipment damage.

## **Battery**

UniRC 7 handheld ground station is equipped with a high-capacity rechargeable lithium-ion battery. Please pay special attention to the following precautions during use:

# SIYI

 Do not charge the controller without the battery inserted.

 If the battery emits smoke, overheats, or bulges, stop using it immediately.

 If the ground unit emits smoke or an unusual odor, stop using it immediately and contact your dealer or the SIYI after-sales service center.

 If the ground unit overheats (above 60°C), stop using it immediately and power it off.

## **Storage, Transport, and Disposal**

When your SIYI product is idle, being transported for field operations, or has reached the end of its service life, please pay close attention to the following:

### **Danger**

Keep idle SIYI products out of reach of children.

Avoid storing SIYI products in excessively hot (above 60°C) or cold (below -20°C) environments.

### **Caution**

Do not store the product in humid or dusty environments.

When carrying or transporting the product, avoid impacts or vibrations that may damage internal components.

# SIYI

## Chapter 1 Product Overview

### 1.1 Product Features

#### 1. Intelligent Dual-Band Video Transmission for Stable Long-Range Vision

UniRC 7 integrates SIYI's next-generation proprietary image transmission technology, featuring a dual-band (2.4/5GHz), dual-receive dual-transmit design. The system automatically selects the optimal channel based on environmental interference, significantly enhancing anti-interference performance and enabling a transmission range of up to 40KM. It supports real-time video transmission at up to 4K 30FPS for a single stream or 1080P 60FPS for dual streams, with a high data rate of 65Mbps and ultra-low latency of 170ms. AES encryption is supported to ensure secure end-to-end data communication.

#### 2. Boundless Connectivity, Built for the Field

##### Typical communication distances in operational scenarios:

- 1) Agricultural spraying (flight altitude 3–6m): 3–6KM
- 2) Suburban areas (120m altitude, light obstruction, moderate interference): 10–15KM
- 3) Over the sea (120m altitude, clear line-of-sight, low interference): 30–40KM

# SIYI

## **3. 7-Inch HD Display – Brilliance in Every Frame**

- 1) 7-inch 1080P HD touchscreen
- 2) 1600-nit ultra-bright display
- 3) Adaptive brightness control

UniRC 7 features a high screen-to-body ratio 7-inch display with 1080P resolution and 1600 nits of brightness, delivering crystal-clear visuals even in direct sunlight. Adaptive brightness adjustment ensures excellent visibility in all lighting conditions, ideal for outdoor operations.

## **4. Innovative Mini Joystick – Precision in Every Detail**

- 1) New mini joystick for custom control:

Allows user-defined functions such as gimbal control, complementing the existing dual main sticks for more flexible operation.

- 2) Innovative quick-release abdomen support :

Soft, ergonomic silicone support enables hands-free use, improving comfort and reducing operator fatigue during prolonged use.

- 3) Unique antenna architecture:

- The ground unit includes built-in dual antennas and detachable foldable external antennas (\*built-in antennas available on UniRC 7 Pro only).
- The air unit (UniRC 7 Pro) features a four-antenna system, including two quick-release and two detachable antennas, boosting signal

# SIYI

reliability and convenience in complex environments.

4) Meticulous industrial design for enhanced ergonomics.

## **5. Android 13 Platform with High-End Configuration**

1) Qualcomm octa-core processor

2) 4GB RAM + 64GB storage

3) 4K 30FPS video decoding capability

Powered by Android 13, UniRC 7 is equipped with a Qualcomm octa-core CPU, 4GB of RAM, and 64GB of internal storage. The system supports 4K 30FPS video decoding, offering smooth performance and robust multitasking capabilities.

## **6. Extended Battery Life for Continuous Operations**

1) Battery life: up to 11 hours (8 hours for UniRC 7 Pro)

2) Supports up to 30W PD fast charging

3) Intelligent temperature protection reduces charging power in high-temperature conditions

4) Quick-release battery design enables easy swaps, ideal for continuous operation scenarios

## **7. Dual Control, Collaborative Operations**

Designed for multi-industry applications, UniRC 7 leverages SIYI's

# SIYI

proprietary wireless HD transmission technology to support multi-device interconnection. Tailored solutions are available for different operational needs, enabling flexible and efficient collaborative control.

# SIYI

## 1.2 Component Description

### 1.2.1 Product Overview

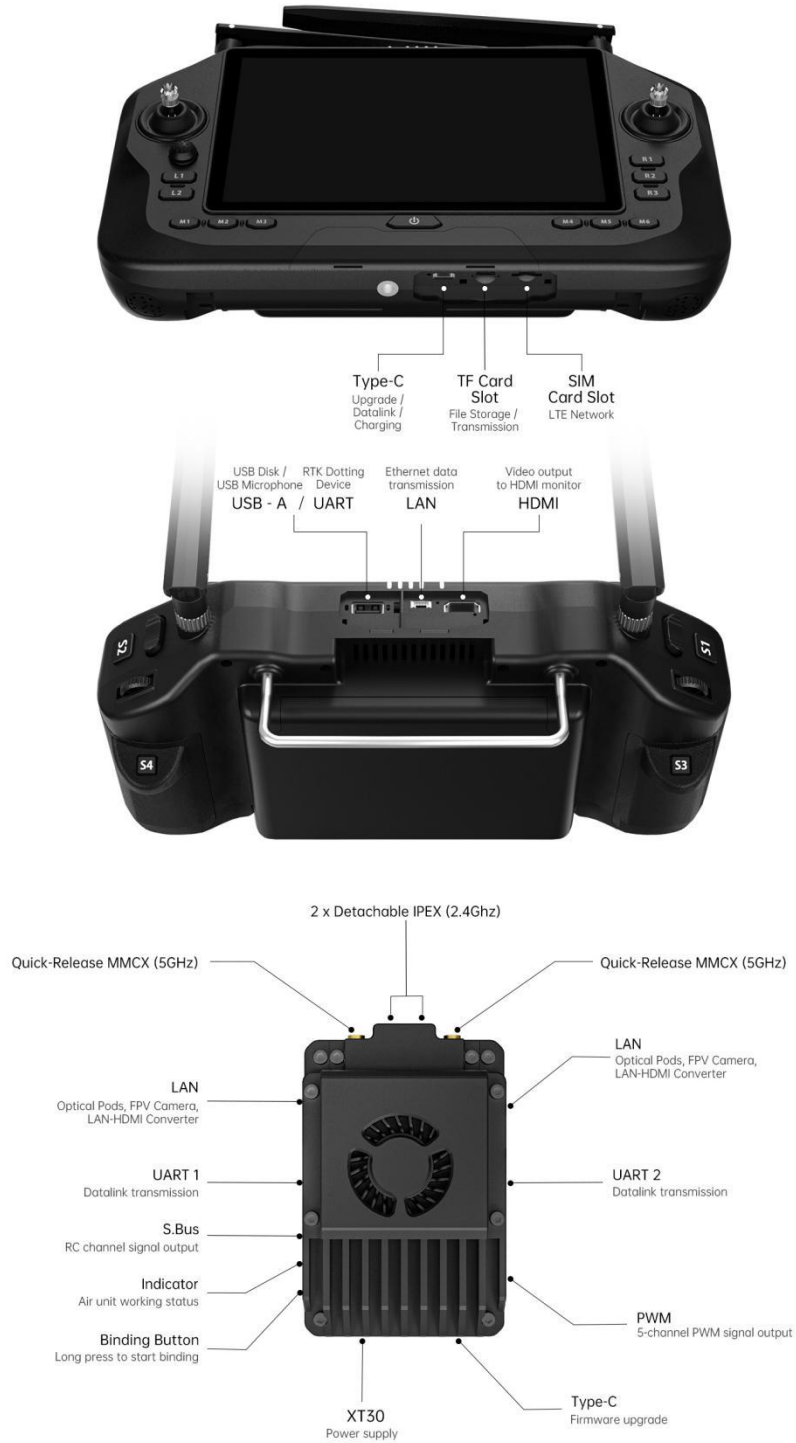

# SIYI

## 1.2.2 Interface Definitions

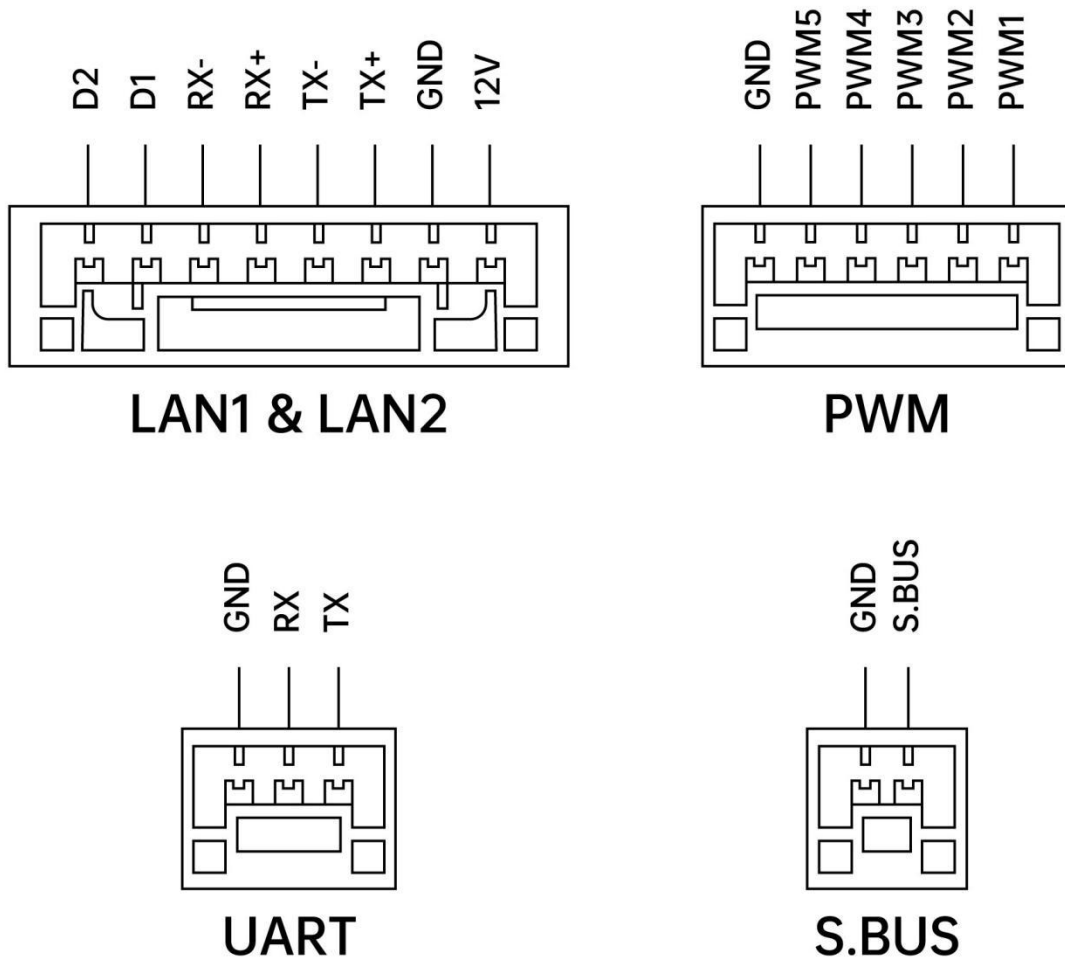

## 1.2.3 Button, Switch Types, and Channel Definitions

Channel No.	Physical Channel Type	Default Physical Switch	Remarks
1	Aileron joystick	J1	
2	Elevator joystick (Mode 2)	J2	
3	Throttle joystick (Mode 2)	J3	
4	Rudder joystick	J4	
5	3-Position Switch (Left)	SA	
6	3-Position Switch (Right)	SB	
7	Top Button (Left)	S1	
8	Top Button (Right)	S2	
9	Rear Button (Left)	S3	
10	Rear Button (Right)	S4	PWM1
11	Mode Button 1	M1	PWM2
12	Mode Button 2	M2	PWM3

# SIYI

13	Mode Button 3	M3	PWM4
14	Mode Button 4	M4	PWM5
15	Mode Button5	M5	Spotlight / Gimbal Pitch Control
16	Mode Button6	M6	Spotlight / Gimbal Re-Centering
--	Mini Joystick - Horizontal	J5	
--	Mini Joystick - Vertical	J6	
--	Function Button (Left 1)	L1	
--	Function Button (Left 2)	L2	
--	Function Button (Right 1)	R1	
--	Function Button (Right 2)	R2	
--	Function Button (Right 3)	R3	
--	Dail wheel (Left)	LD	
--	Dail wheel(Right)	RD	
--		RSSI	

## 1.3 Technical Specifications

### General Performance

<p><b>Typical Operating Scenarios Communication Range</b></p>	<p>Agricultural missions at a flight altitude of 3–6 meters: 3–6 km communication range</p> <p>Suburban missions at a flight altitude of 120 meters with low obstructions and moderate interference: 10–15 km communication range</p> <p>Maritime missions at a flight altitude of 120 meters with unobstructed line of sight and low interference: 30–40 km communication range</p> <p>The above parameters apply to both UniRC 7 and UniRC 7 PRO.</p>
<p><b>Image Transmission Operating Frequency</b></p>	<p>UniRC 7 Pro: 2.4015 GHz - 2.4815 GHz 5.725 GHz - 5.850 GHz</p> <p>UniRC 7 : 2.4015 GHz - 2.4815 GHz</p>
<p><b>Physical Channels</b></p>	<p>16 Push Buttons, 2 Three-Position Switches, 2 Large Joysticks, 1 Mini Joystick, 2 Dials</p>
<p><b>Operating Temperature</b></p>	<p>-20°C - 55°C</p>

### Ground Control Station (GCS)

<p><b>Display</b></p>	<p>7-inch Touchscreen LCD</p> <p>Brightness: 1600 nits</p> <p>UniRC 7 Pro: 1920×1200</p> <p>UniRC 7: 1280×800</p>
<p><b>Operating System: Android</b></p>	<p>Android 13</p>
<p><b>Storage</b></p>	<p>4GB RAM + 64GB ROM *Expandable via microSD card</p>

# SIYI

<b>Wi-Fi</b>	Wi-Fi 5
<b>Bluetooth</b>	BT 5.0
<b>GNSS</b>	GPS/GLONASS/BeiDou/Galileo/QZSS
<b>Battery Life</b>	UniRC 7 Pro: Approx. 8 hours UniRC 7: Approx. 11 hours
<b>Battery Capacity</b>	13400mAh
<b>Charging Method</b>	PD 30W
<b>Data Transmission Interfaces/SDK</b>	UART/UDP, Bluetooth (Data Transmission), TYPE-C
<b>Functional Interfaces</b>	USB-A (default external USB drive, supported only by UniRC 7 Pro, can be configured as a serial port) Ethernet Port (GH1.25 4Pin, supported only by UniRC 7 Pro) HDMI (supported only by UniRC 7 Pro) Type-C (for charging, file transfer, and firmware upgrade) TF Card Slot SIM Card Slot
<b>Antennas</b>	UniRC 7 Pro: 2 foldable detachable antennas + 2 built-in antennas UniRC 7: 2 foldable detachable antennas
<b>Ingress Protection (IP) Rating</b>	IP54
<b>Overall Dimensions</b>	274 mm (L) × 190 mm (W) × 100 mm (H)
<b>Weight</b>	UniRC 7 Pro: 1.46 kg UniRC 7: 1.44 kg

## Air Unit

<b>Remote Signal Output</b>	16-channel S.Bus 5-channel PWM
<b>Function Interfaces</b>	(GH1.25 6Pin) Data Transmission: UART × 2 (GH1.25 3Pin) Image & Data: Ethernet × 2 (GH1.25 8Pin) Power Input: XT30 Firmware Upgrade: Type-C Data Transmission: UART × 2 (GH1.25 3Pin)
<b>Antennas</b>	UniRC 7 Pro: 2 × Quick-Release Antennas (5G MMCX) + 2 × Detachable Antennas (2.4G IPEX) UniRC 7: 2 × Detachable Antennas (2.4G IPEX)
<b>Power Supply Voltage</b>	12-76V
<b>Dimensions (excluding antennas)</b>	UniRC 7 Pro: 63 (L) × 40 (W) × 27 (H) mm UniRC 7: 57 (L) × 40 (W) × 28 (H) mm
<b>Weight (excluding antennas)</b>	UniRC 7 Pro: 115 g UniRC 7: 90 g
<b>Average Power Consumption:</b>	UniRC 7 Pro: 8 W UniRC 7: 6 W

# SIYI

## 1.4 Item List

### Standard Package















<b>UniRC 7</b>	<b>UniRC 7 PRO</b>
1 x UniRC 7 Ground Unit 2 x 2.4G Omnidirectional Antennas	1 x UniRC 7 PRO Ground Unit 2 x Standard 2.4G Omnidirectional Antennas
1 x UniRC 7 Air Unit 2 x 2.4G Omnidirectional Antennas	1 x UniRC 7 PRO Air Unit 2 x 2.4G Omnidirectional Antennas 2 x 5G Omnidirectional Antennas
1 x PX4 / ArduPilot Autopilot Data Cable 1 x S.Bus Male Connector Cable 1 x PWM Cable	
1 x 30W PD Fast Charger (Type-C, US Standard) 1 x PD Fast Charge Data Cable (Type-C to Type-C) 1 x Type-C to USB-A Adapter 1 x Storage Case 2 x Quick-Release Belly Supports	
1 x 30W PD Fast Charger (Type-C, US Standard) 1 x PD Fast Charge Data Cable (Type-C to Type-C) 1 x Type-C to USB-A Adapter 1 x Storage Case 2 x Quick-Release Belly Supports	
1 x Ground Unit Shoulder Strap	1 x Ground Unit Shoulder Strap

# SIYI









## 1.5 Status Indicator Definitions

status indicators on the SIYI link ground unit and air unit use different colors and flashing frequencies to represent different meanings.









### 1.5.1 Ground Unit Indicator Definitions

-  Solid red: No communication between ground and air unit
-  Fast red flashing: Pairing in progress
-  Slow red flashing: Firmware mismatch
-  Red flashing three times: Link initialization failed
-  Red flashing four times: Stick calibration required on ground unit
-  Alternating red and green flashing: Android system unexpectedly shut down
-  Alternating red, green, and yellow slow flashing: Video transmission starting or the image transmission firmware is being upgraded
-  Alternating red, green, and yellow flashing at intervals: Upgrade the air unit firmware
-  Slow yellow flashing: Abnormal power voltage on ground unit
-  Yellow flashing twice: Bluetooth not detected on ground unit
-  Yellow-red: Ground unit temperature level 1 warning
-  Yellow-red-red: Ground unit temperature level 2 warning
-  Yellow-red-red-red: Ground unit temperature level 3 warning
-  Three yellow flashes: Image transmission firmware mismatch















# SIYI

-  Green solid or flashing: The faster the flash, the weaker the signal strength
-  Solid green: 100% valid packet rate
-  Green flashing (1Hz): 99%–95% valid packet rate
-  Green flashing (interval 3/5 seconds): 75%–50% valid packet rate
-  Green flashing (interval 3/10 seconds): 50%–25% valid packet rate
-  Green flashing (interval 1/25 seconds): Valid packet rate less than 25%
-  Green-red: Air unit temperature level 1 warning
-  Green-red-red: Air unit temperature level 2 warning
-  Green-red-red-red: Air unit temperature level 3 warning

## 1.5.2 Air Unit Indicator Definitions

-  Solid red: No communication between ground and air unit
-  Fast red flashing: Pairing in progress
-  Slow red flashing: Firmware mismatch
-  Red flashing three times: Link initialization failed
-  Alternating red, green, and yellow slow flashing: Video transmission starting or the image transmission firmware is being upgraded
-  Yellow flashing: Voltage warning (input voltage below 12V)
-  Green solid or flashing: The faster the flash, the weaker the signal strength
-  Solid green: 100% valid packet rate
-  Green flashing (1Hz): 99%–95% valid packet rate

# SIYI

-  Green flashing (interval 3/5 seconds): 75%–50% valid packet rate
-  Green flashing (interval 3/10 seconds): 50%–25% valid packet rate
-  Green flashing (interval 1/25 seconds): Valid packet rate less than 25%
-   Alternating green and red flashing: Wireless pairing initiated (triggered by powering on three times)
-   Green-red: Air unit temperature level 1 warning
-    Green-red-red: Air unit temperature level 2 warning
-     Green-red-red-red: Air unit temperature level 3 warning

## 1.5.3 Dual-Control Mode Indicator Definitions

1. In dual-control mode of one aircraft, when the master control allows the slave control to take command, both the master and slave controls flash simultaneously.
2. In remote control relay mode, the end with control authority has an indicator light that flashes, while the end without control authority remains steadily lit.

In the above scenarios, the flashing frequency is set at 5-second intervals, with the indicator light flashing three times.

## Chapter 2 Before Use

### 2.1 Ground Unit

#### 2.1.1 Power On and Off

##### **Power On:**

When powered off, press the power button briefly for about 1 second until the indicator light turns on. Then press and hold the power button for about 2 seconds until the screen lights up. The device will then power on and enter working mode.

##### **Power Off:**

When powered on, press and hold the power button for about 2 seconds. A system popup will appear—tap the power-off icon to shut down the ground unit.



##### **Caution**

**Forced Shutdown:** When powered on, press and hold the power button for approximately 8 seconds to forcibly shut down the ground unit.



##### **Tip**

**Screen Off:** When powered on, press the power button briefly to turn off the screen and enter power-saving mode.

# SIYI

## 2.1.2 Charging

The UniRC 7 handheld ground station supports charging in both power-on and power-off states using the original 30W PD fast charger.

When charging while powered on, if the internal temperature becomes too high, the ground station will automatically reduce the charging power until the temperature drops.

### Steps for Use

1. Use a Type-C fast charging cable to connect the ground station to the original 30W PD fast charger.
2. If the battery indicator LEDs flash in sequence, it means charging is in progress.
3. When all four battery indicator LEDs remain steadily lit, charging is complete.



### Note

Do not charge the remote controller without the battery installed.

# SIYI

## 2.1.3 Charging Indicator Definitions

Description: ● indicates ON; ○ indicates OFF; ⊙ indicates Flashing

	First Indicator	Second Indicator	Third Indicator	Fourth Indicator
0-25%	⊙	○	○	○
26%-50%	●	⊙	○	○
51%-75%	●	●	⊙	○
76%-99%	●	●	●	⊙
100%	●	●	●	●

## 2.1.4 Switching System Language

SIYI handheld ground station's Android system supports almost all available languages, which can be easily switched in the system settings menu.

### Note

The default language of the Android system upon delivery is Simplified Chinese.

# SIYI

## Step

1. Go to the Android system settings menu.

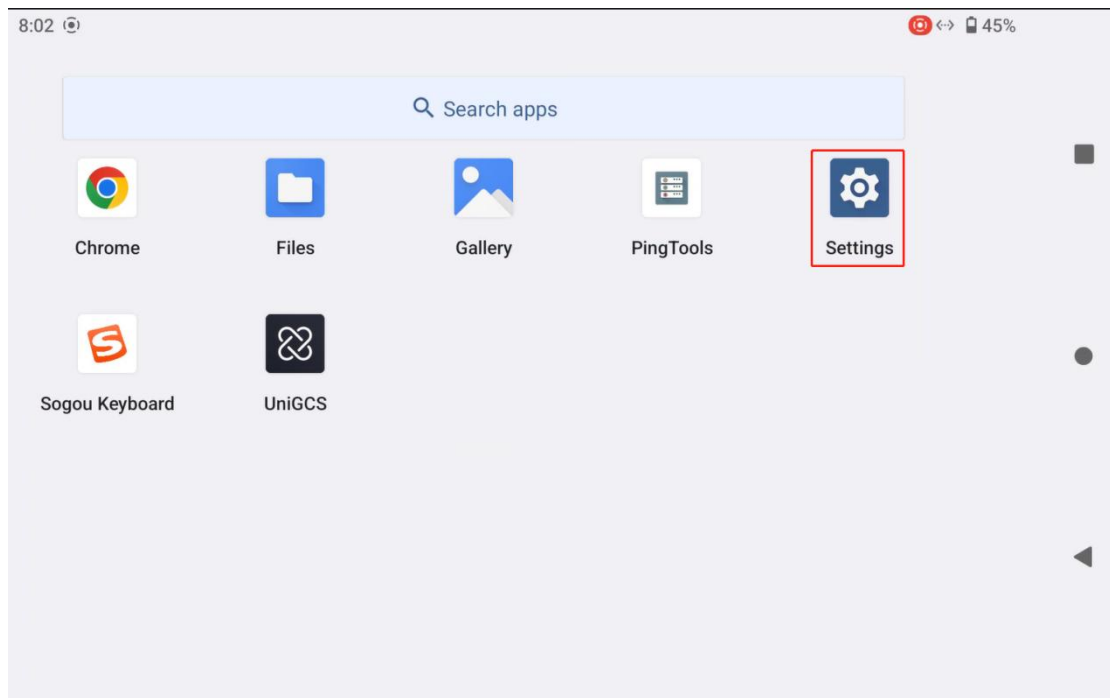

2. Scroll down the page to find the "System (Languages, time, backup, updates)" menu and enter it.

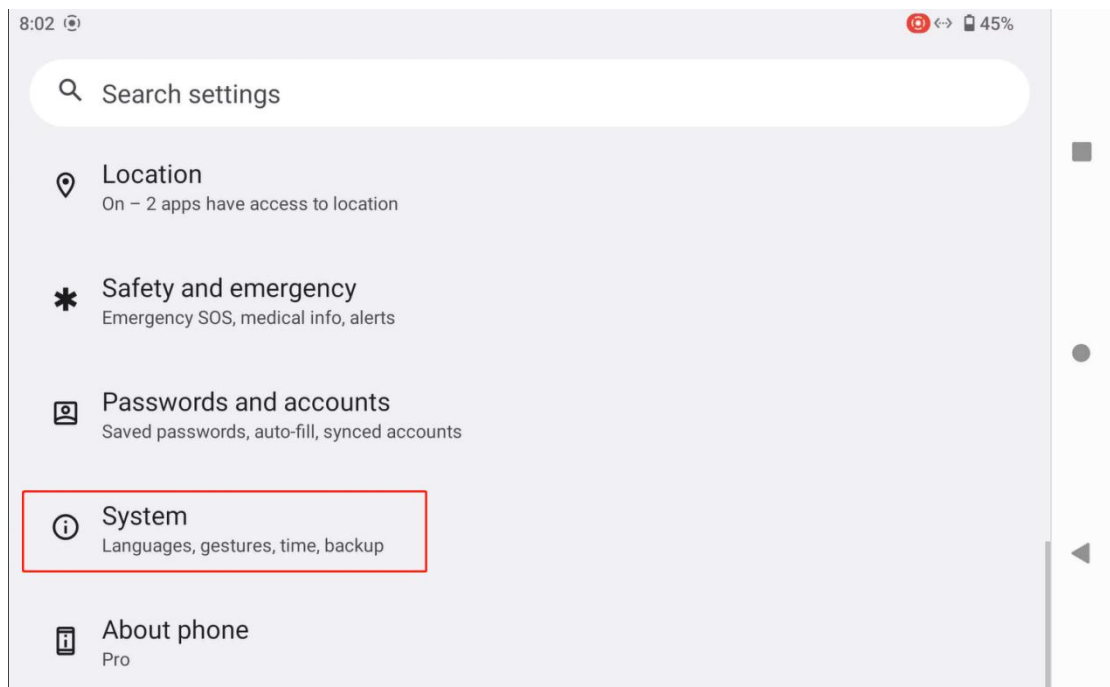

# SIYI

3. Then enter the "Languages & input" menu, select "Languages", and tap "Add a language".

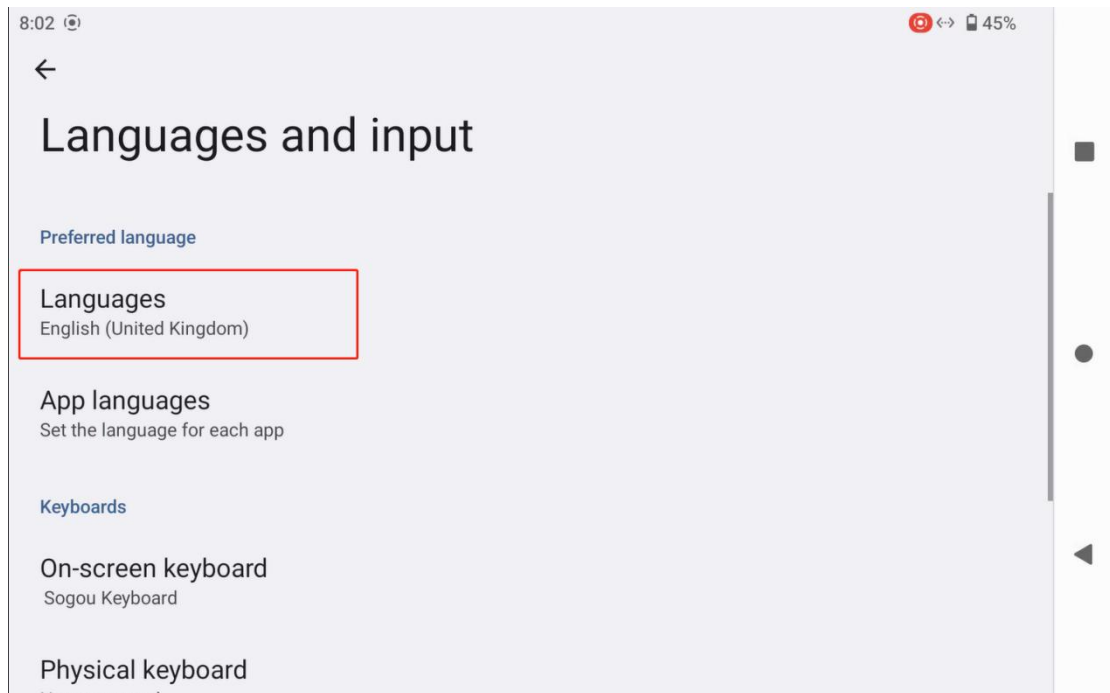
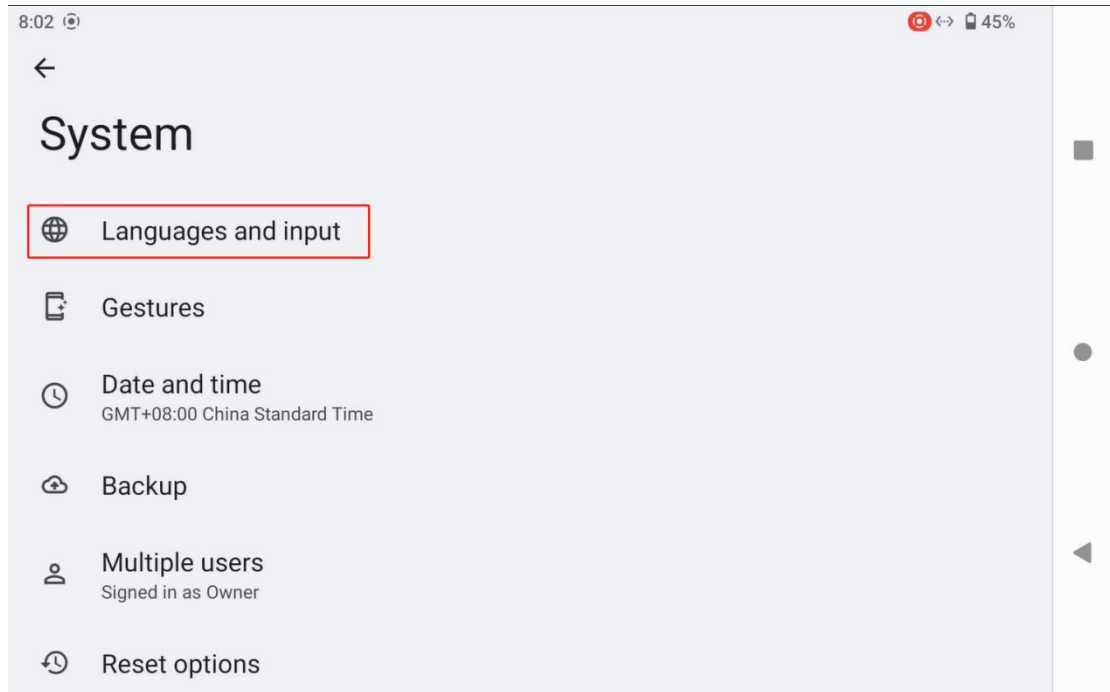

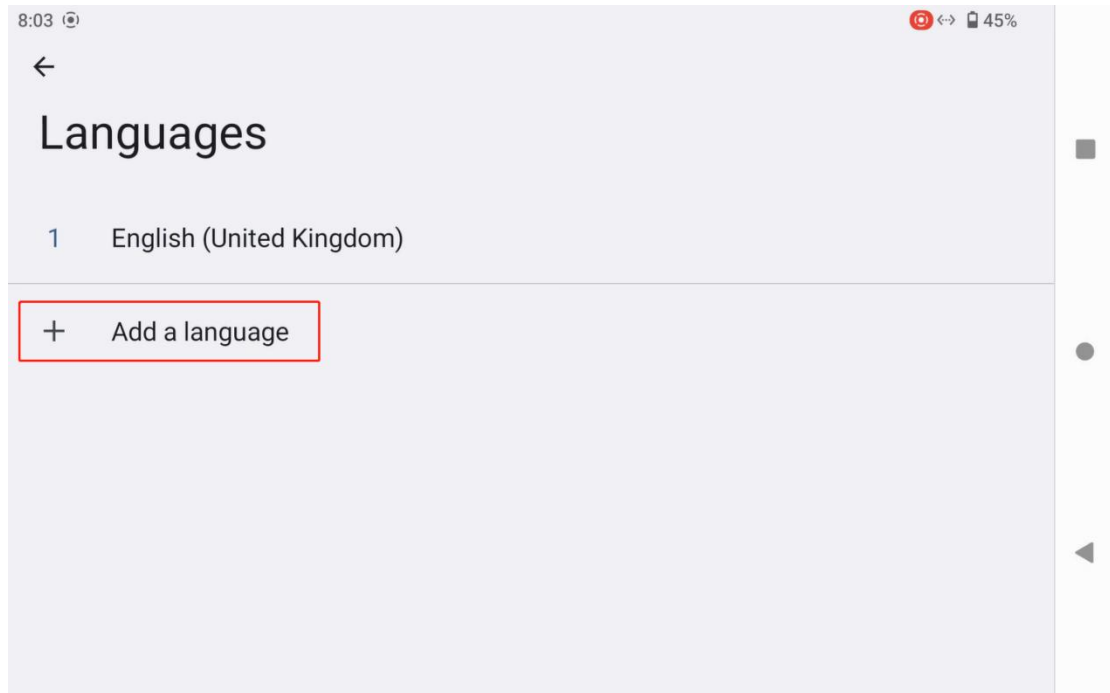

4. Take American English as an example: scroll down the page to find "English", then select "United States". The page will automatically return to the "Languages & preferences" screen.

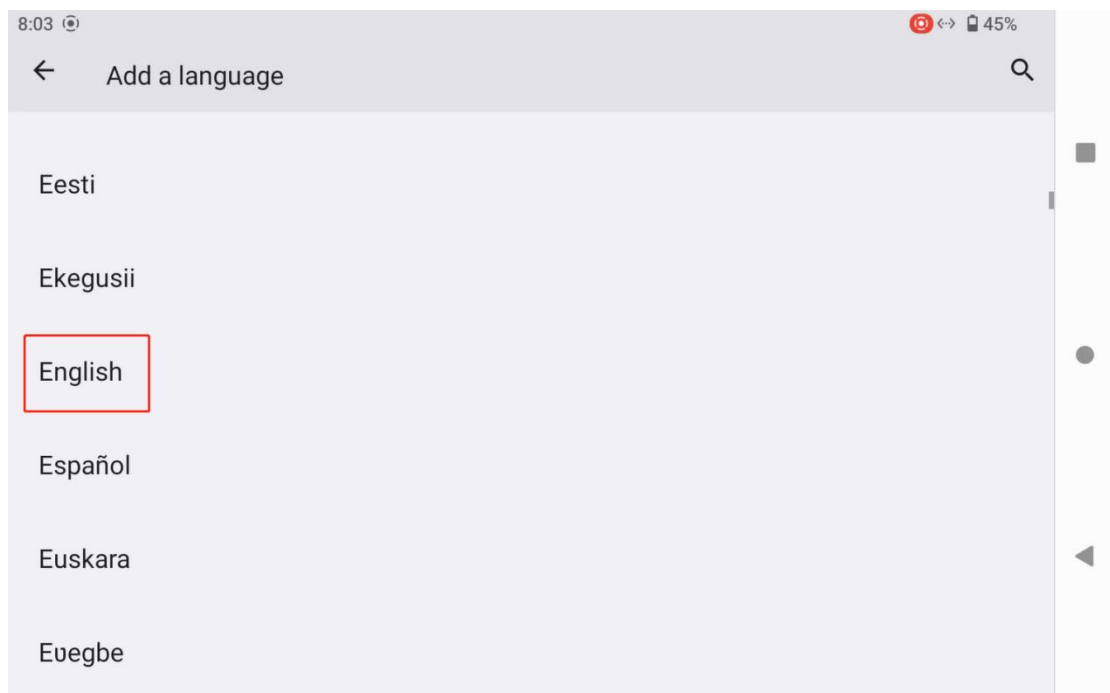

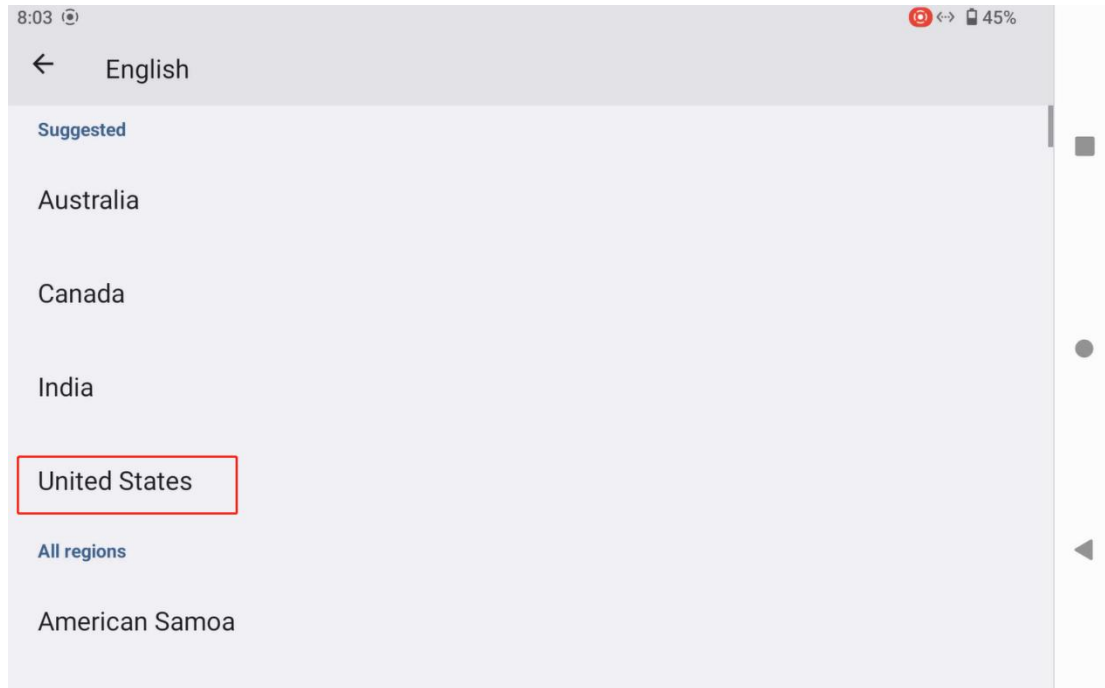

5. Drag the newly added “English (United States)” language bar upward to the first position. The system language will automatically switch to American English.

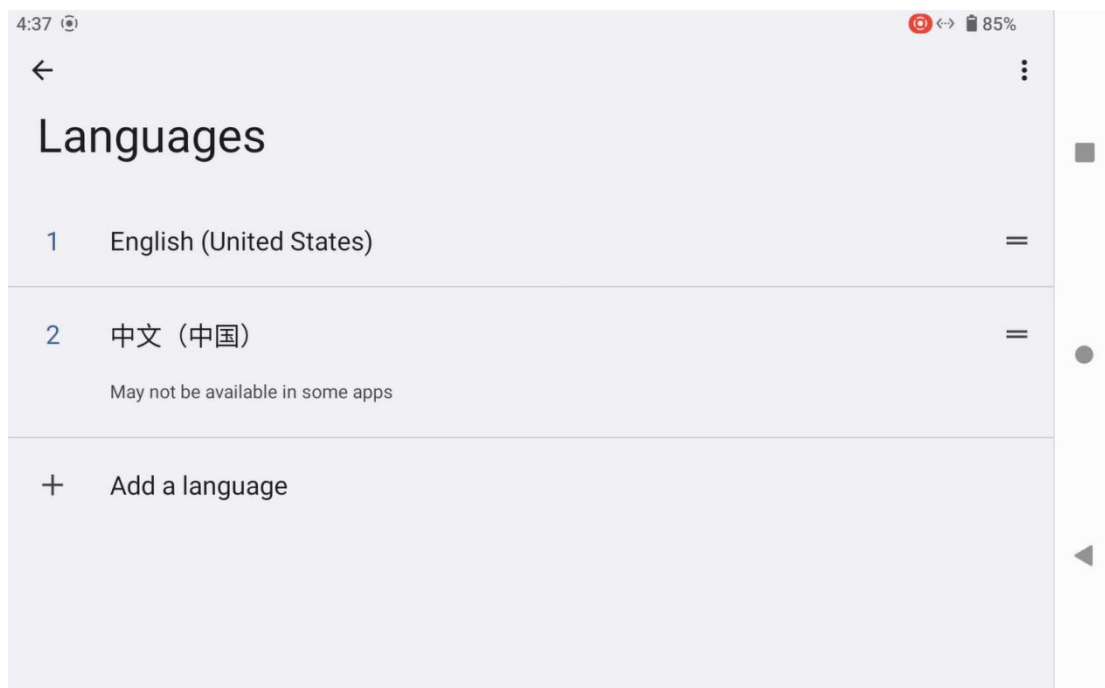

# SIYI

## **2.2 Important Instructions for Enhancing Communication Range and Video Smoothness**

To maximize the communication range and video smoothness of the UniRC 7 link, please read this instruction carefully and install the antennas and configure the link according to the guidelines.

### **2.2.1 Usage Precautions**

1. Do not simultaneously use the UniGCS app and RTSP streaming software such as QGroundControl to pull video streams, as background streaming also consumes image transmission bandwidth and affects range.
2. Only power the Air Unit with a propulsion battery interface, since HD image transmission requires high current, instant current response, and low ripple from the power supply. Do not modify the Air Unit power supply privately, as it may affect link stability and transmission range.

### **2.2.2 Installation and Placement of the Standard Omnidirectional Antenna on the Ground Unit**

1. The SMA antenna connector must be tightened securely.
2. The antenna should be placed vertically upward relative to the ground unit control panel, keeping the flat side of the antenna always facing

# SIYI

the aircraft. Antennas must not be stacked or crossed. Please refer to the following illustration:



## 2.2.3 Installation and Placement of the Standard Omnidirectional Antenna on the Air Unit

1. The SMA antenna connector must be tightened securely.
2. The MMCX and IPEX antenna connectors must be firmly plugged in.
3. On multi-rotor drones, the air unit's standard omnidirectional antenna

# SIYI

should be mounted vertically downward relative to the aircraft frame; on fixed-wing aircraft, the antenna can be mounted vertically upward. During flight, try to keep the flat side of the antenna facing the ground unit.

4. The antenna feeder cable should be routed away from ESCs, motors, and other high-current power devices with strong electromagnetic interference.
5. The air unit's standard feeder cables must not be crossed. The antenna body, feeder cable, and SMA connector should avoid direct contact with metal or carbon fiber structural parts and maintain at least a 10mm gap.
6. The four antennas on the air unit should be spaced apart, with at least 50mm between them. During flight, avoid any obstacles blocking communication between the aircraft and ground unit.
7. Do not pull forcefully or bend excessively the antenna feeder cables and connectors on both ends, as this may cause antenna damage. When adjusting antenna angles or orientation, try to bend only the middle section of the feeder cable.

## **Note**

As shown in the figure below, for small to medium multi-rotor drones, the air unit antenna should be positioned vertically downward along the

# SIYI

drone arm to keep the flat side of the antenna facing the direction of the ground unit.



As shown in the figure below, for large multi-rotor drones, the air unit antenna should be mounted vertically downward relative to the motor mount, ensuring that the flat side of the antenna faces directly toward the ground unit.

# SIYI



As shown in the figure below, for fixed-wing aircraft, the air unit antenna can be mounted vertically upward on the wing or vertical tail, while also keeping the flat side of the antenna facing toward the ground unit as much as possible.

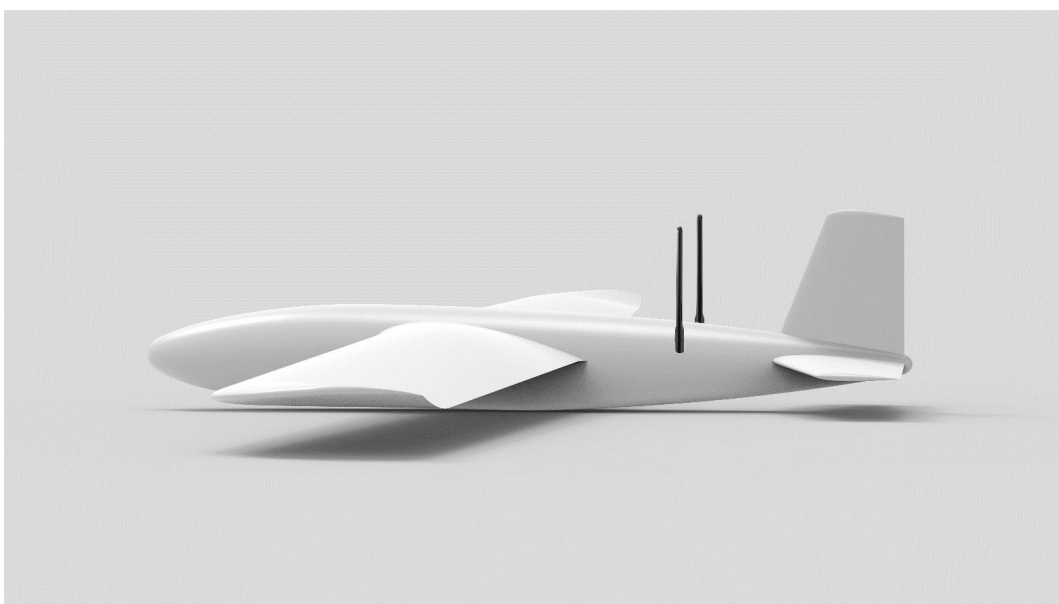

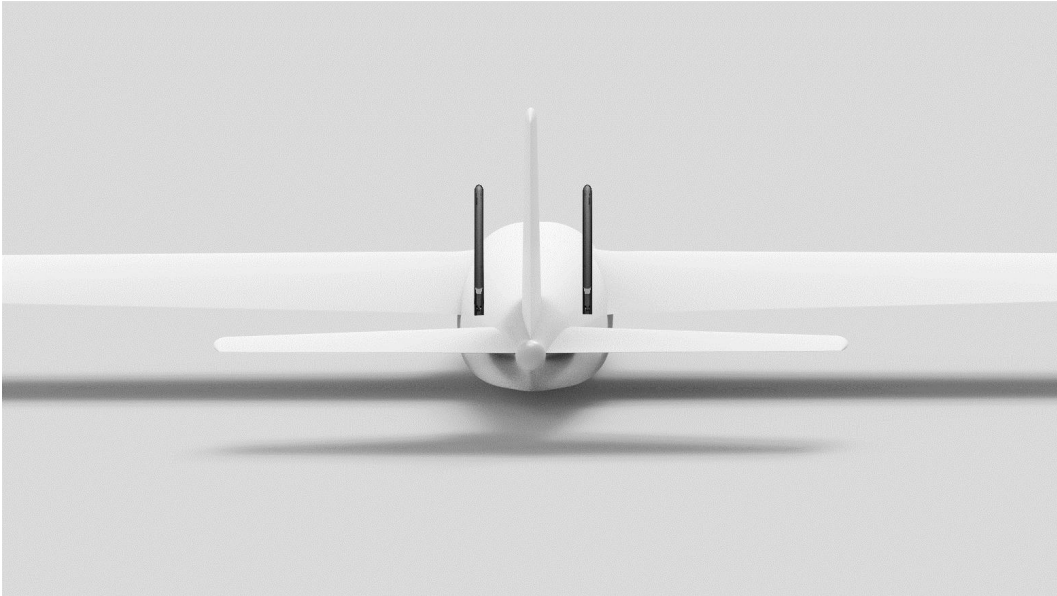

## **2.2.4 Necessary Information Required Before Requesting Factory**

1. Direct symptoms that make you feel the communication distance is insufficient:
  - Signal loss: image loss, ground unit status indicator light shows red
  - Image loss only (ground unit status indicator light shows green)
2. Flight distance and flight altitude of the drone when the above symptoms are observed
3. Flight test environment (provide photos or videos showing the drone's flight direction)

## 4. Check communication-related software information:

- Transmission working mode and frequency band

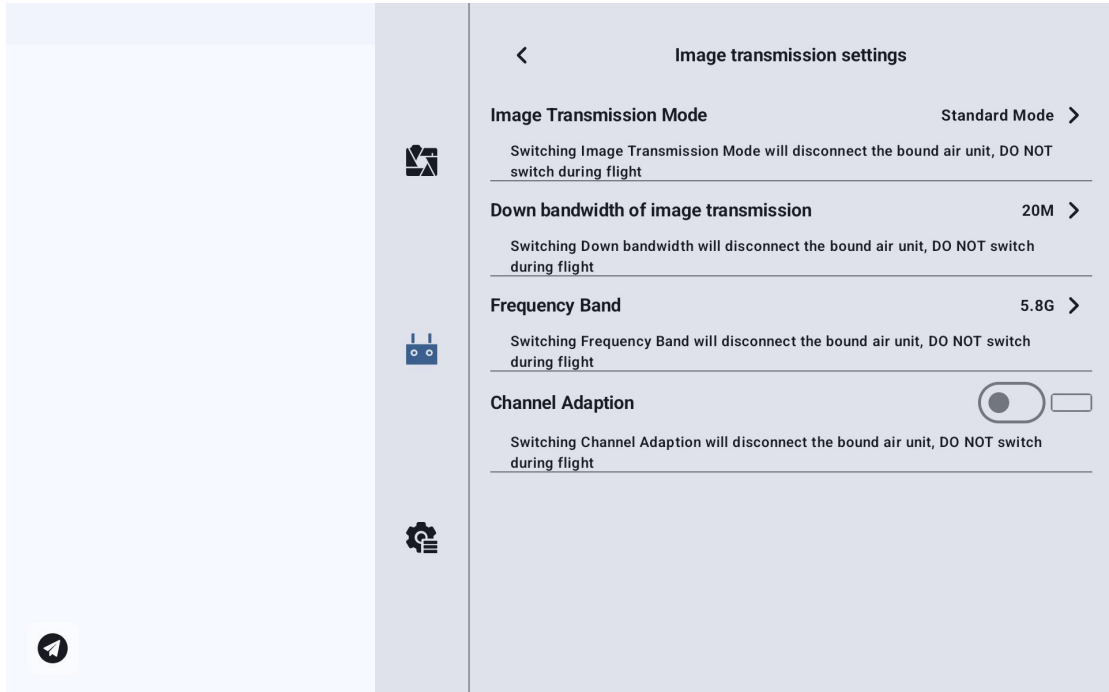

- Firmware versions of the ground unit and the air unit

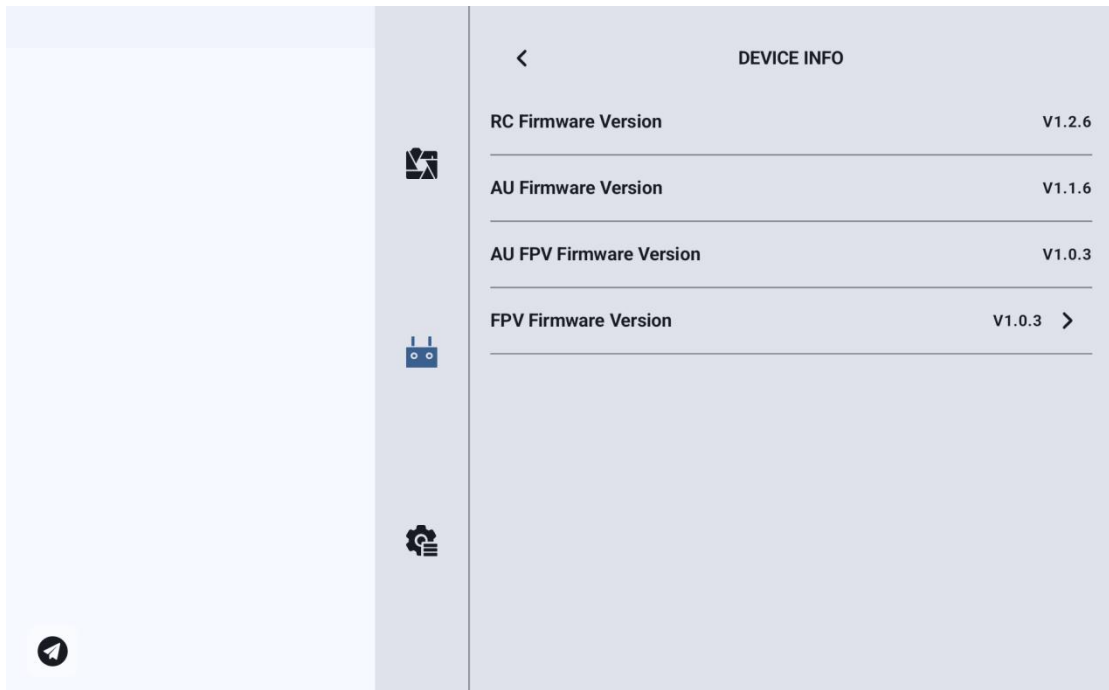

- UniGCS Application Version

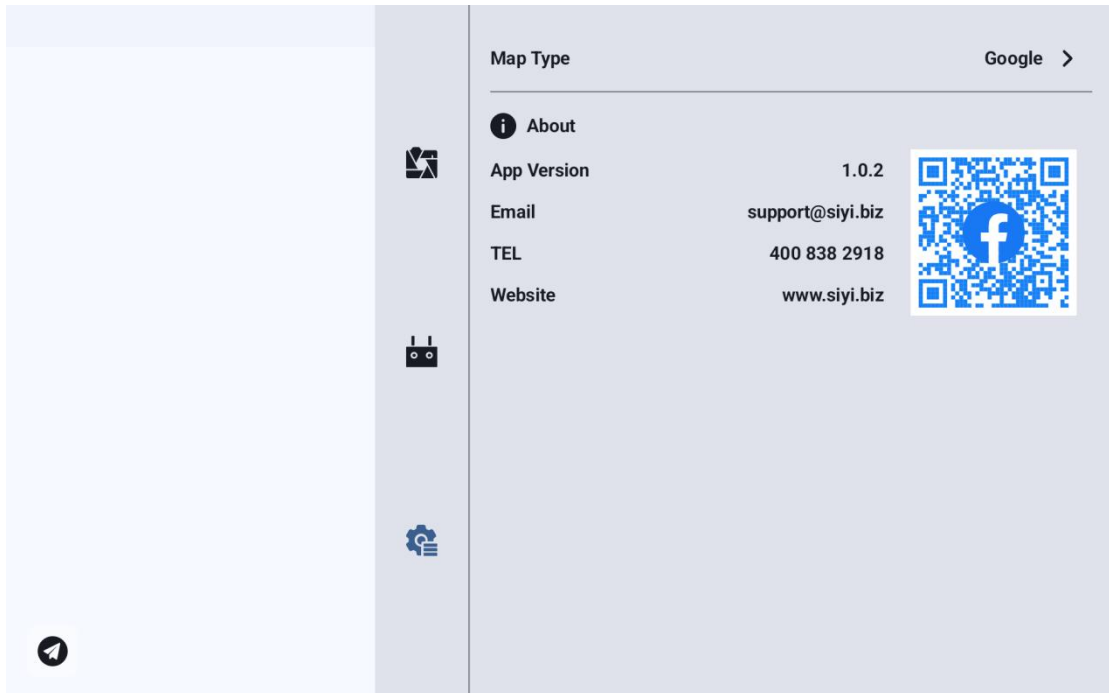

5. Check hardware configurations related to communication

- Type, installation angle, and usage angle of the ground unit antenna (provide photos)
- Type and installation angle of the air unit antenna (provide photos)
- Power supply method and voltage of the air unit; has the power module been modified?

6. If the problem persists after checking the above, please provide a flight test recording of the link status screen in the UniGCS application near the maximum communication range.

## Chapter 3 UniGCS Application

parameter settings through the UniGCS application.

### 3.1 Flight Interface and Map Interface

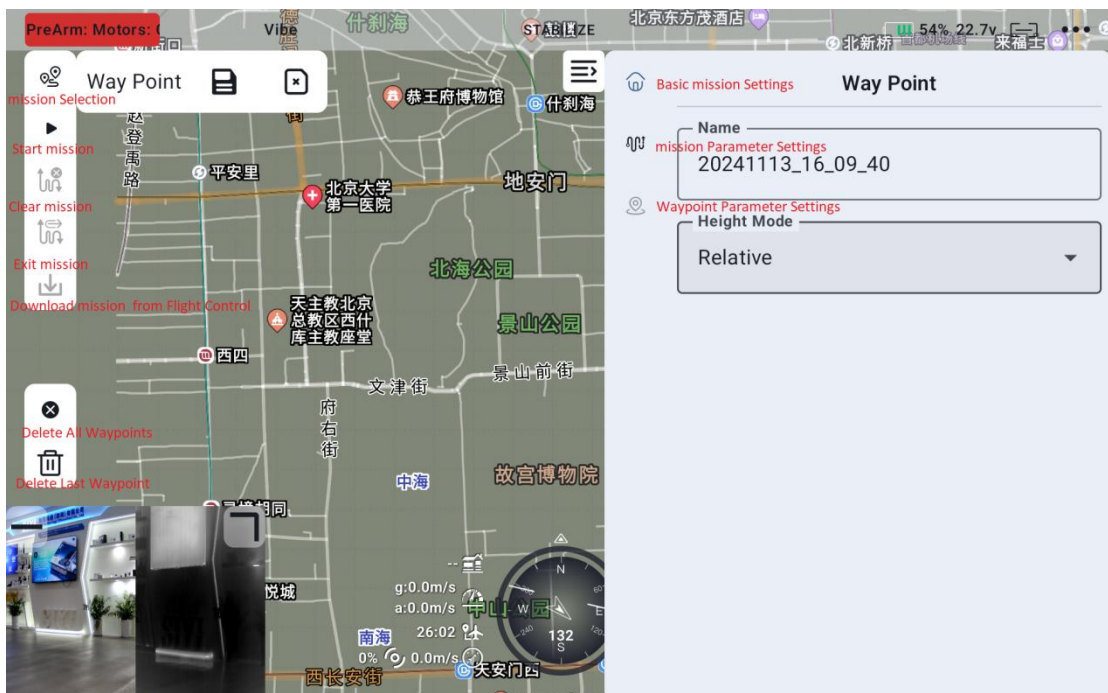

# SIYI

## 3.2 Gimbal Settings

### 3.2.1 Connecting the Gimbal

After connecting the gimbal to the Air Unit's network port, select the corresponding SIYI gimbal in either Camera A or Camera B.

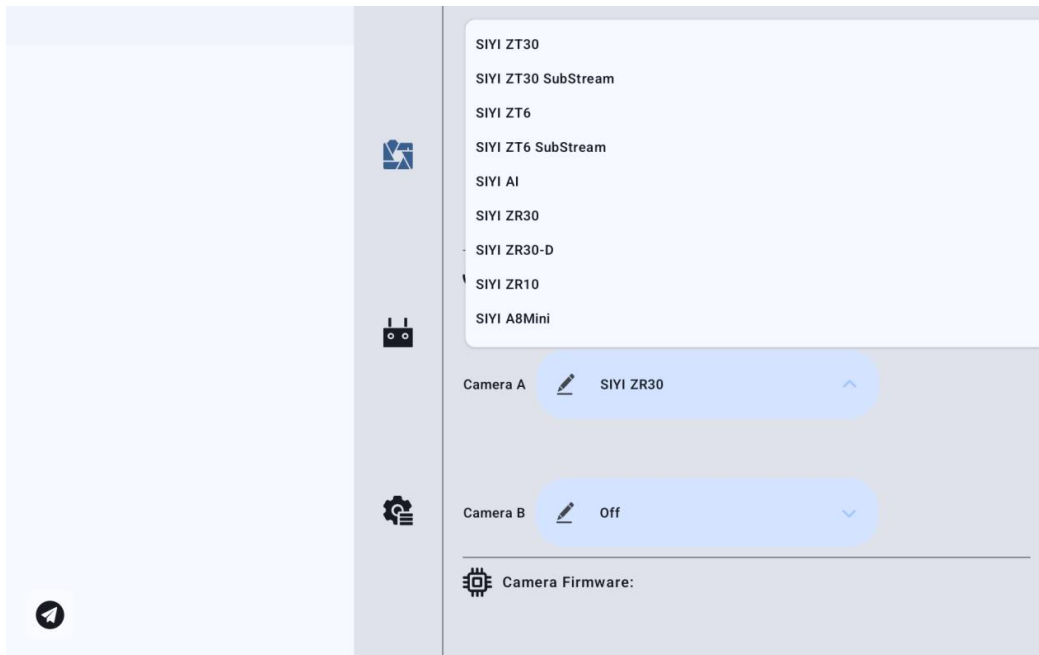

You can also choose to manually enter the RTSP address to connect.

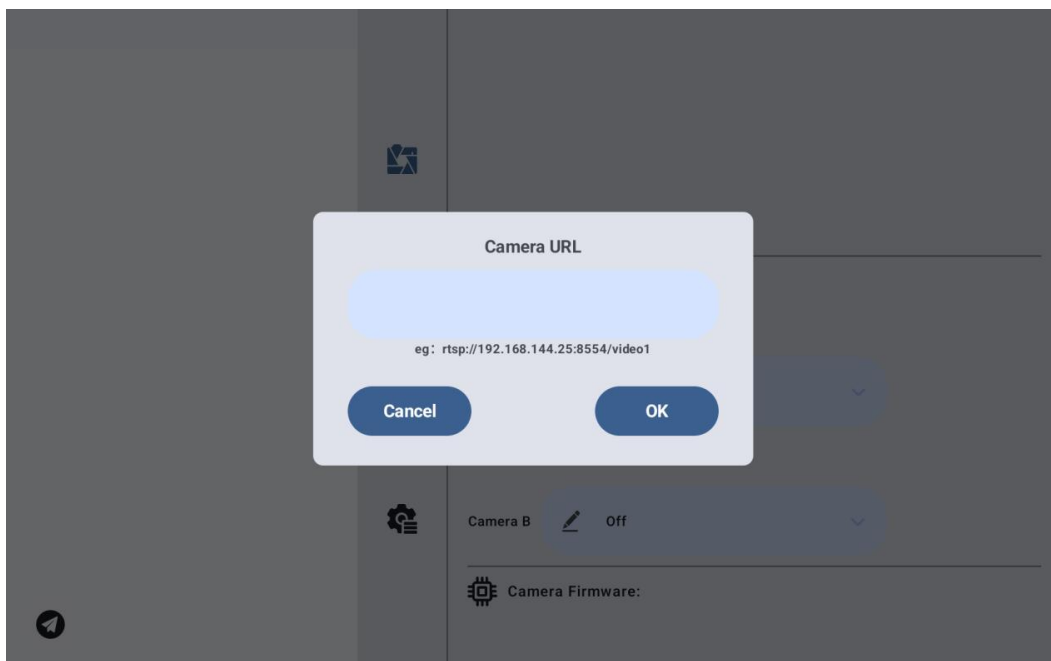

## Note:

When connecting two gimbals simultaneously, you need to change the IP address of one gimbal to a non-.25 ending. When connecting, select manual RTSP address input to establish the connection.

## 3.3 Remote Controller Settings

### 3.3.1 Joystick Modes

The UniRC 7 supports switching between “Mode 1 (Japanese style)”, “Mode 2 (American style)”, and “Mode 3 (Chinese style)”.

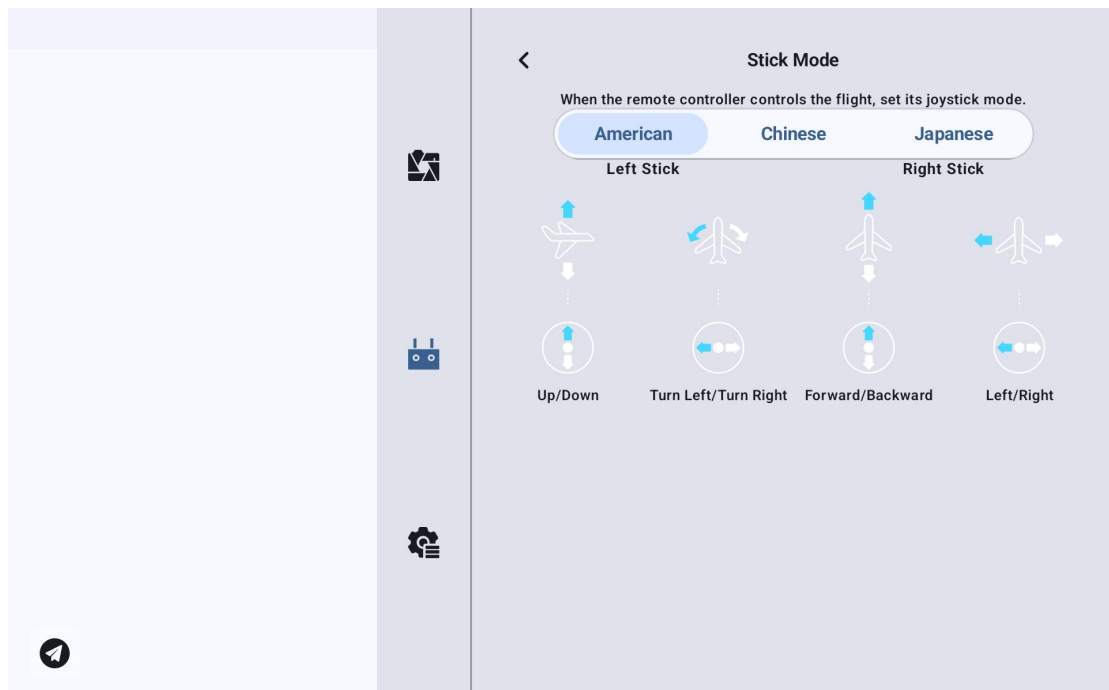

## 3.3.2 Remote Controller Calibration

The remote controller calibration function helps users calibrate the center position and maximum limits of the handheld ground station's joysticks and dials. Regular joystick calibration helps maintain accurate output from the joystick channels.

### 3.3.2.1 Joystick Calibration Steps

1. Before starting joystick calibration, ensure the handheld ground station's left and right joysticks are naturally at rest, without any displacement caused by external forces.
2. In the "Joystick Calibration" menu, click "Start Calibration" to enter the following interface:

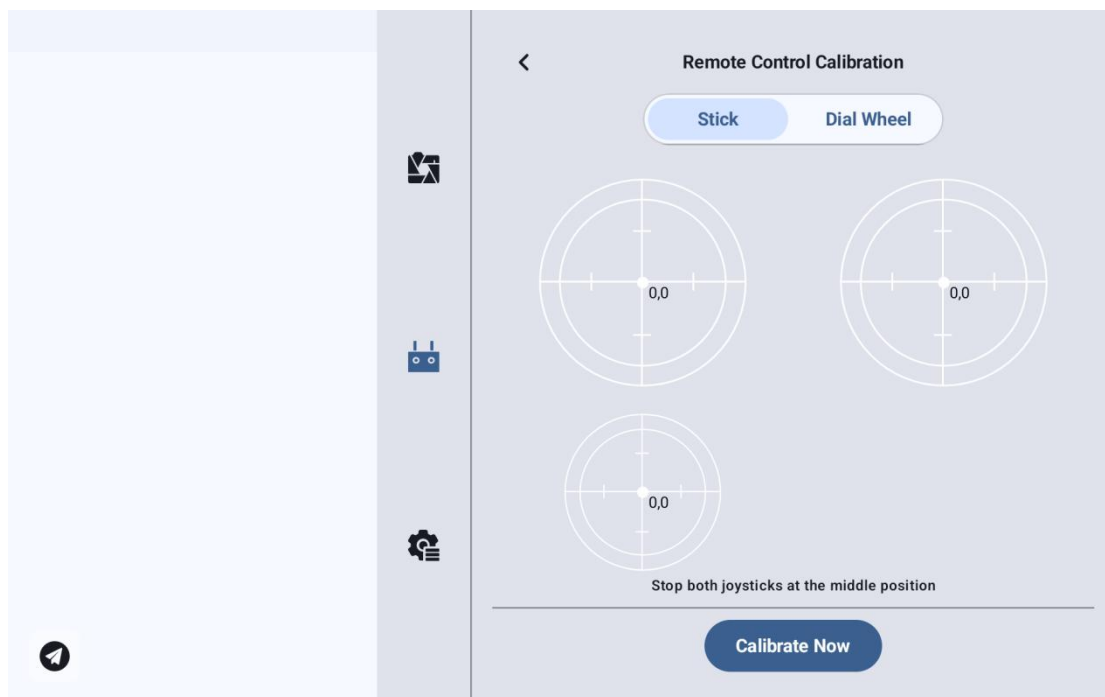

3. Follow the prompts: if the joystick is naturally at rest but the joystick channel output value is not zero, it indicates the neutral point of the

# SIYI

joystick has shifted. At this time, do not touch the joystick and wait for the neutral point calibration to complete.

4. When the following prompt appears, it means the neutral point calibration is completed, and you can proceed to calibrate the maximum limits.

Follow the on-screen instructions to push each joystick sequentially to the maximum limit in all directions.

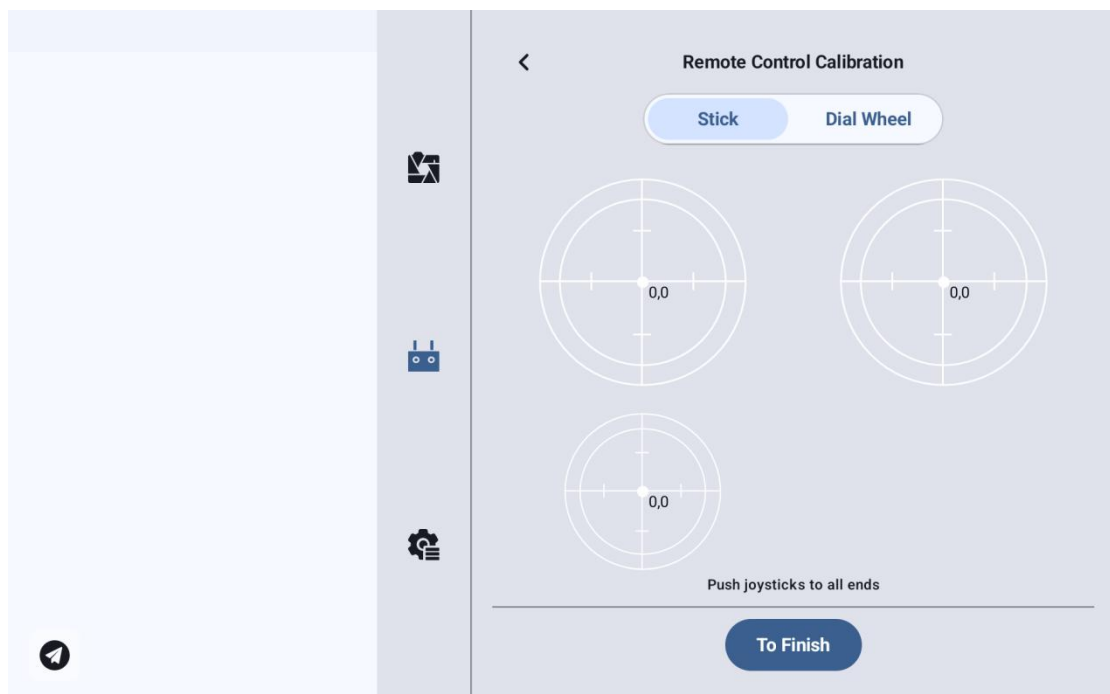

Up: (0, 100)

Down: (0, -100)

Left: (-100, 0)

Right: (100, 0)

Then click "Complete Calibration."

5. The "Joystick Calibration" menu will display "Calibration Successful."

## Note:

If the joystick does not return to the center position when naturally at rest (channel output value is not 0), or if pushing the joystick to its limits does not produce the maximum or minimum output values (-100, 100), calibration should be performed immediately.

### 3.3.2.2 Dial Calibration Steps

1. Before calibrating the dial, ensure that the left and right dials on the handheld ground station are naturally at rest, without any displacement caused by external force.
2. In the "Dial Calibration" menu, click "Start Calibration" to enter the following interface:

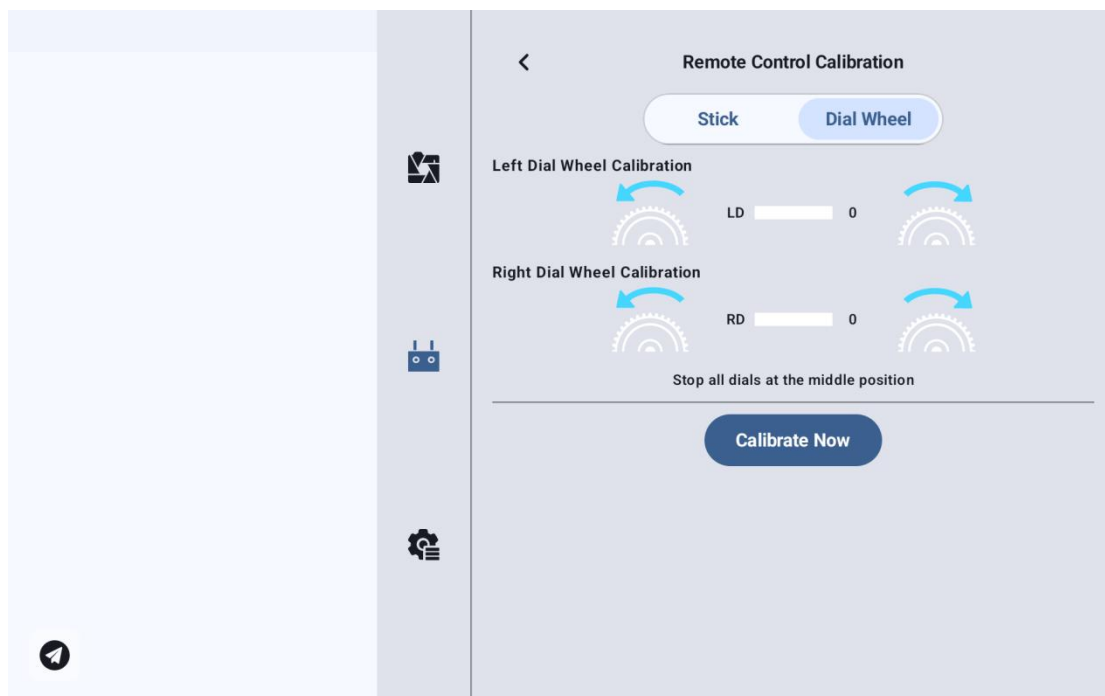

3. Follow the prompts: if the dial is naturally at rest but the dial channel output value is not 0, it indicates that the dial's neutral point has shifted. At this time, do not touch the dial and wait for the neutral point calibration to complete.

# SIYI

4. When the prompt as shown below appears, it means the neutral point calibration is complete. Next, calibrate the maximum limits.

Follow the on-screen instructions to move each dial to its maximum limit positions in all directions one by one.

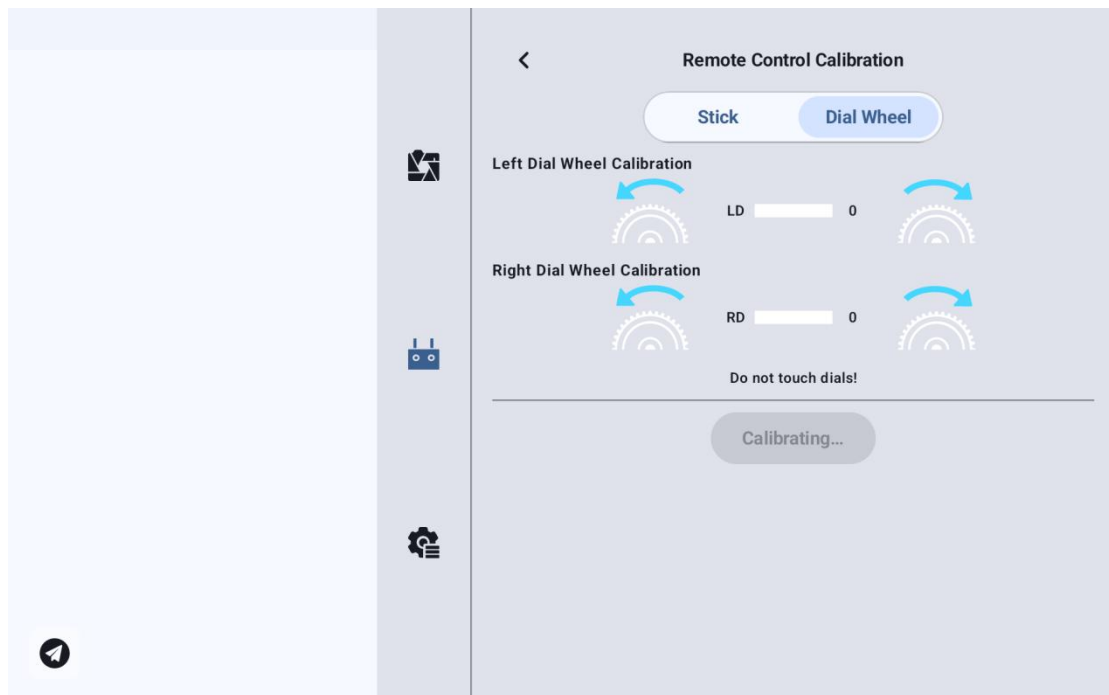

Left: -100

Right: 100

5. The "Dial Calibration" menu will return to the initial screen, indicating the calibration is complete.

# SIYI

## 3.3.3 Data Transmission Settings

The Data Transmission Settings menu allows users to identify the handheld ground station device ID, configure the data transmission connection mode, and set specific serial port baud rates.

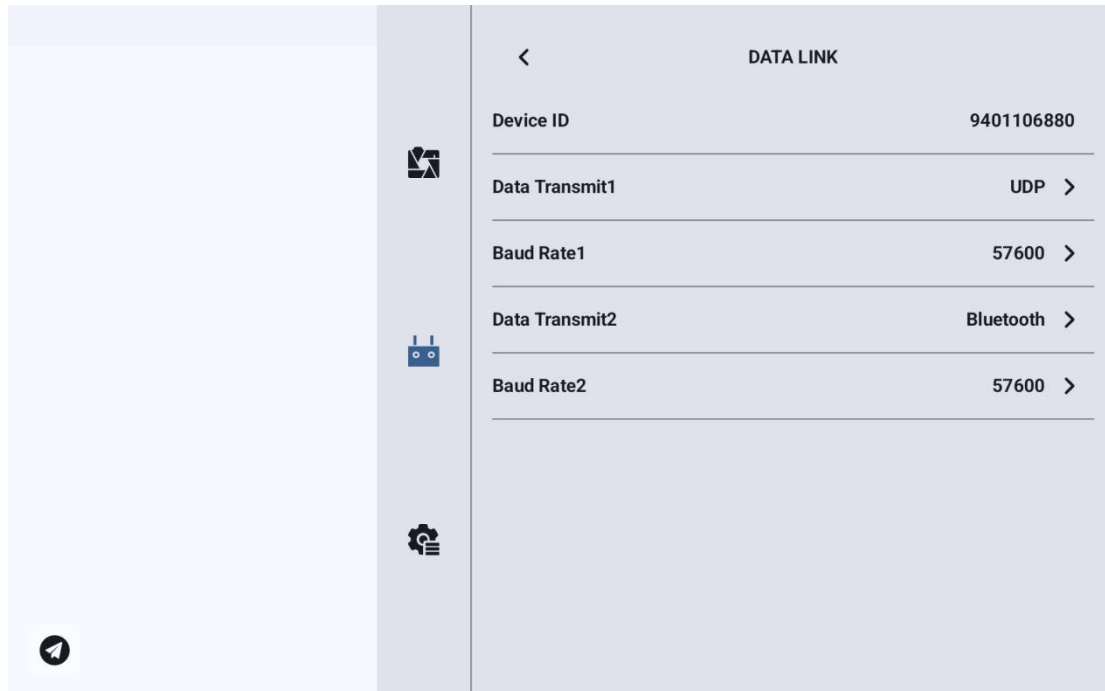

### 3.3.3.1 About Data Transmission Settings

**Device:** Displays the serial number of the Bluetooth module integrated within the handheld ground station. During Bluetooth pairing, this serial number is recognized as the corresponding Bluetooth name. This serial number is unique for each ground station unit.

**Data Transmission 1:** The data transmission connection mode for the device connected to the Air Unit TELEM 1 port.

**Serial Port Baud Rate 1:** Should be set to match the baud rate of the

# SIYI

device connected to the Air Unit TELEM 1 port.

Data Transmission 2: The data transmission connection mode for the device connected to the Air Unit TELEM 2 port.

Serial Port Baud Rate 2: Should be set to match the baud rate of the device connected to the Air Unit TELEM 2 port.

### 3.3.3.2 Connection

The UniRC 7 handheld ground station supports the following data transmission connection modes: Bluetooth, Upgrade, UART Serial Port, and UDP.

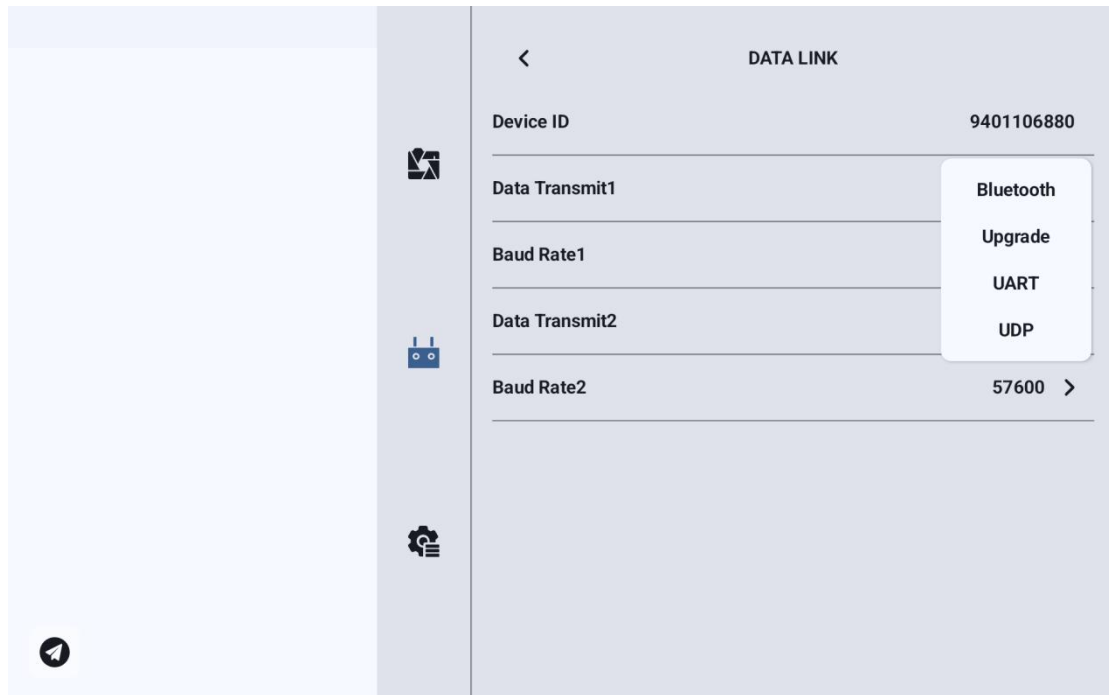

UART Serial Port: Data transmission communication is conducted via the built-in UART serial port of the ground station (developers can refer to the data transmission SDK documentation in Chapter 6 of this manual to develop support for this function on their own ground stations).

# SIYI

Bluetooth: Data transmission communication is carried out via the built-in Bluetooth wireless connection of the ground station (supports the majority of ground station software and also supports data transmission communication with external devices such as Windows-based ground station software).

Upgrade: Establishes data transmission communication with external devices, such as Windows ground station software, through the Type-C interface located at the bottom of the handheld ground station.

UDP: Data transmission communication is conducted via UDP network protocol connection.

### 3.3.3.3 Serial Port Baud Rate

Please manually select the matching serial port baud rate setting.

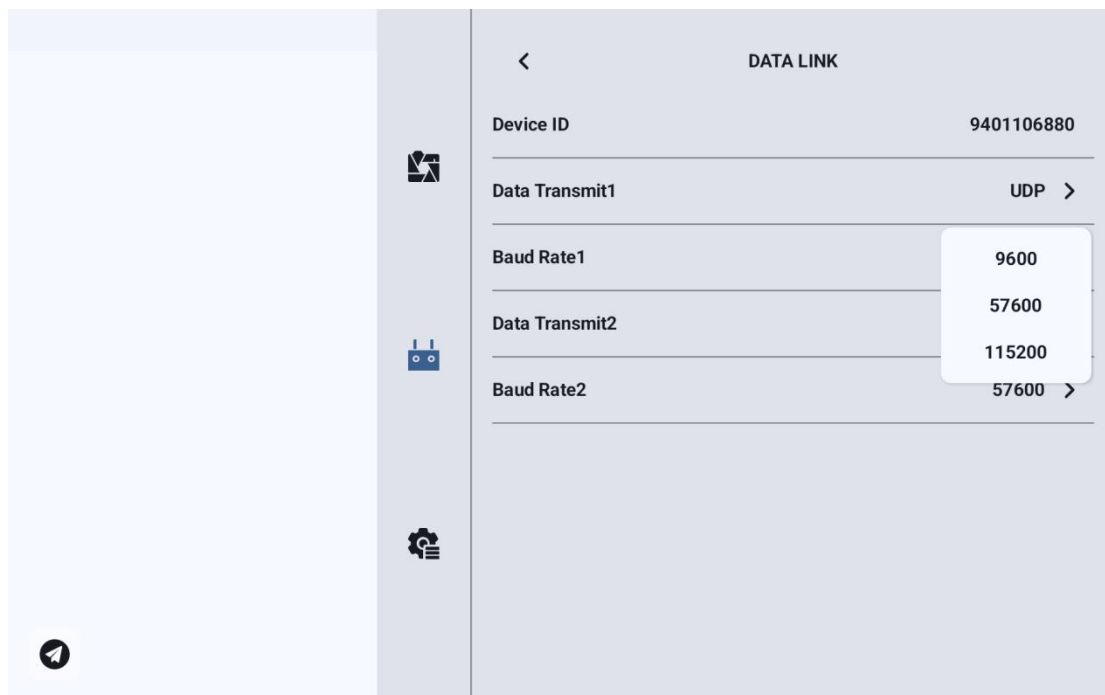

# SIYI

## Note:

Before changing the serial port baud rate, please ensure that the Ground Control Station (GCS) and Air Unit have successfully paired; otherwise, the setting will not take effect.

### 3.3.4 Channel Settings

The channel settings feature allows users to configure the servo travel range, neutral position, servo direction reversal, and channel mapping for each channel on the handheld ground station.

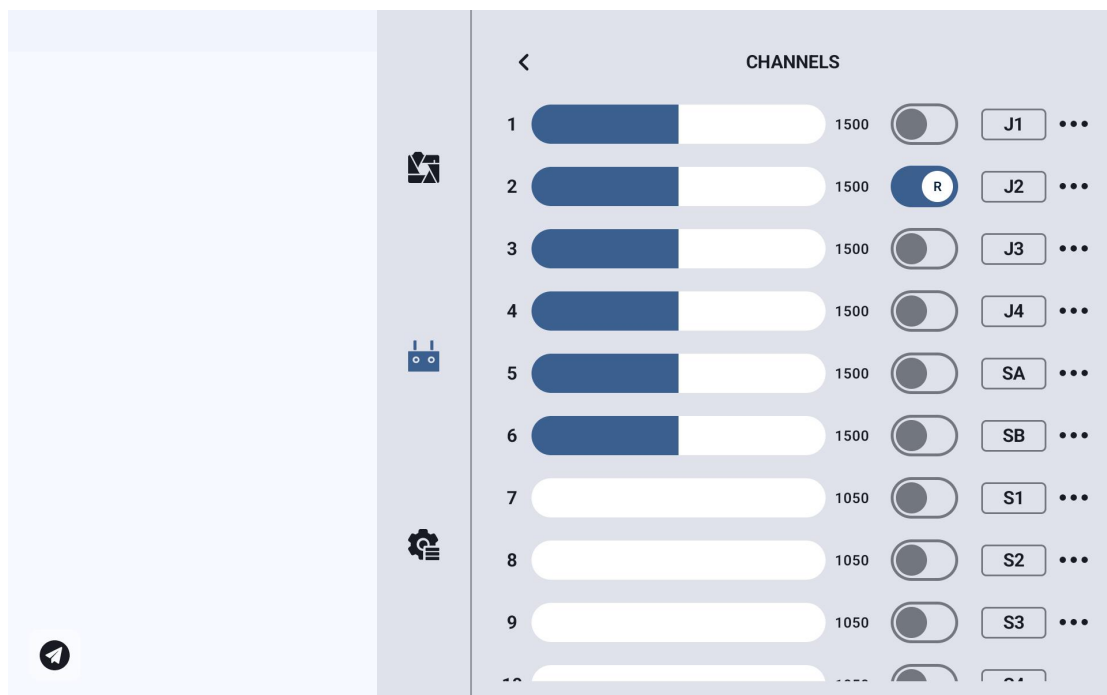

# SIYI

## 3.3.4.1 Servo Travel Volume

The UniRC 7 handheld ground station has a default servo travel range from 1050 to 1950.

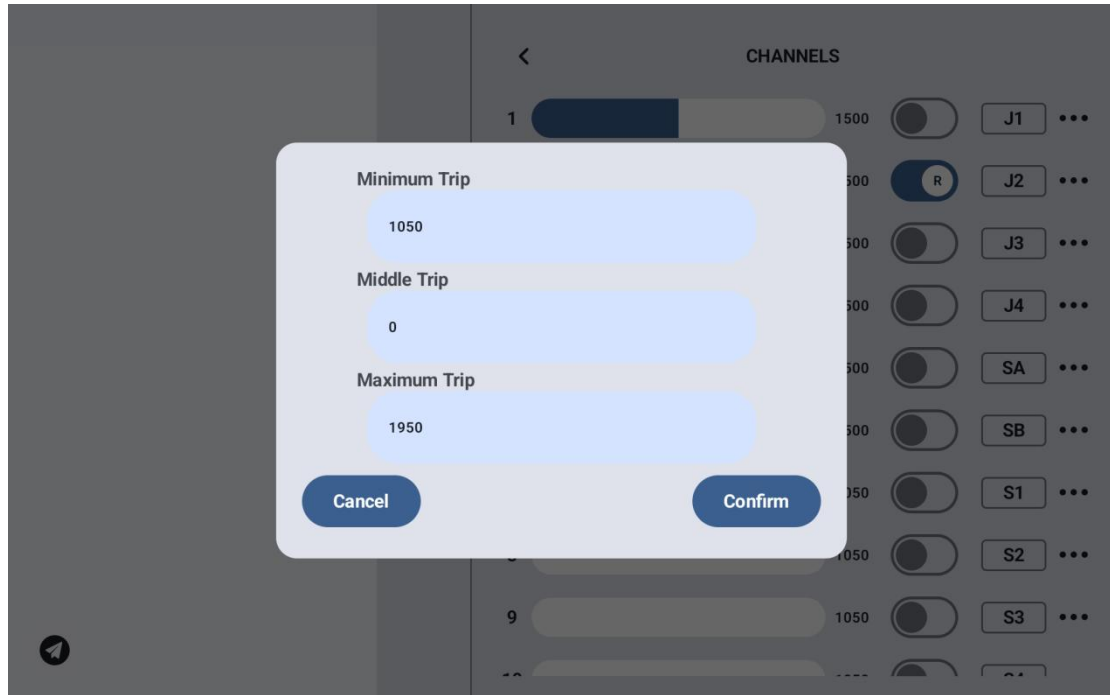

Select the target channel and enter the desired travel range value to successfully modify it.

The default neutral position for the travel range is 1500.

Select the target channel and enter the desired neutral point offset value to successfully update it.

### **Note:**

The neutral position offset range is  $\pm 500$ .

For example, to set the neutral point to 1700, set the neutral offset to +200. To set the neutral point to 1300, set the neutral offset to -200.

# SIYI

## 3.3.4.2 Servo Reversal

The servo reversal function is used to invert the output direction of the channel's travel range.



Select the target channel, then click the corresponding servo direction toggle switch to successfully set the servo to normal or reversed direction.

## 3.3.4.3 channel assign

The UniRC 7 handheld ground station supports a total of 26 physical channels and 16 communication channels. It allows users to freely define the mapping relationships between physical buttons, switches, joysticks, and communication channels through the channel mapping function.

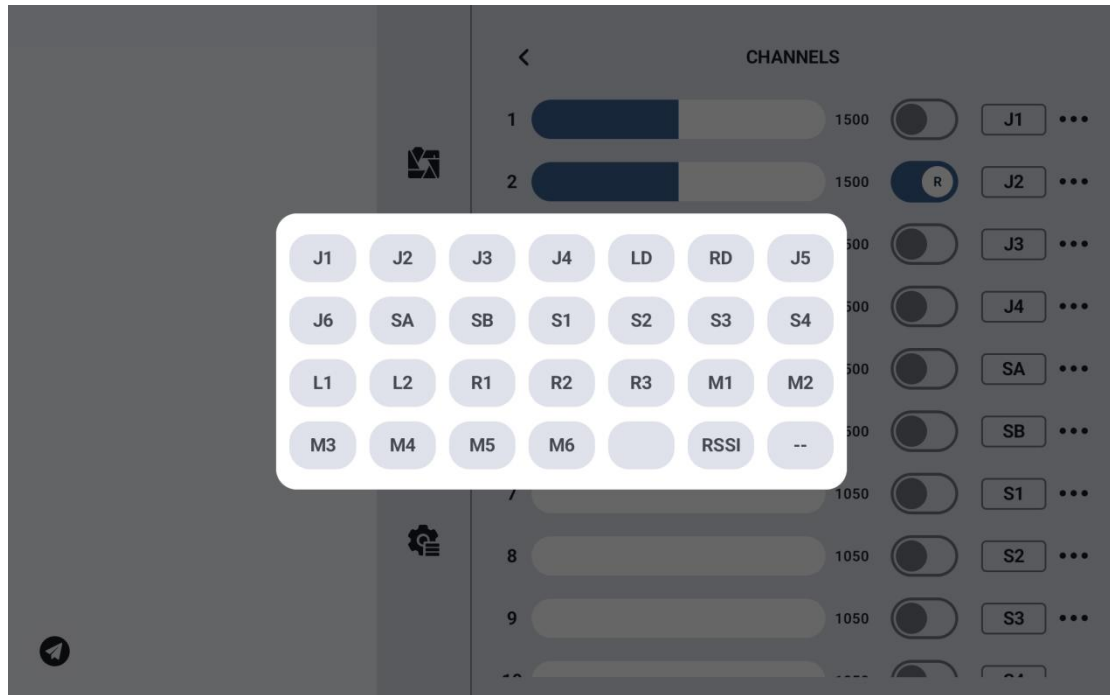

Select the target channel and click the channel mapping button. A switch list will pop up—choose the desired switch to successfully complete the connection.

## 3.3.5 Link Status

Displays real-time link status information to intuitively show the quality of the wireless communication.

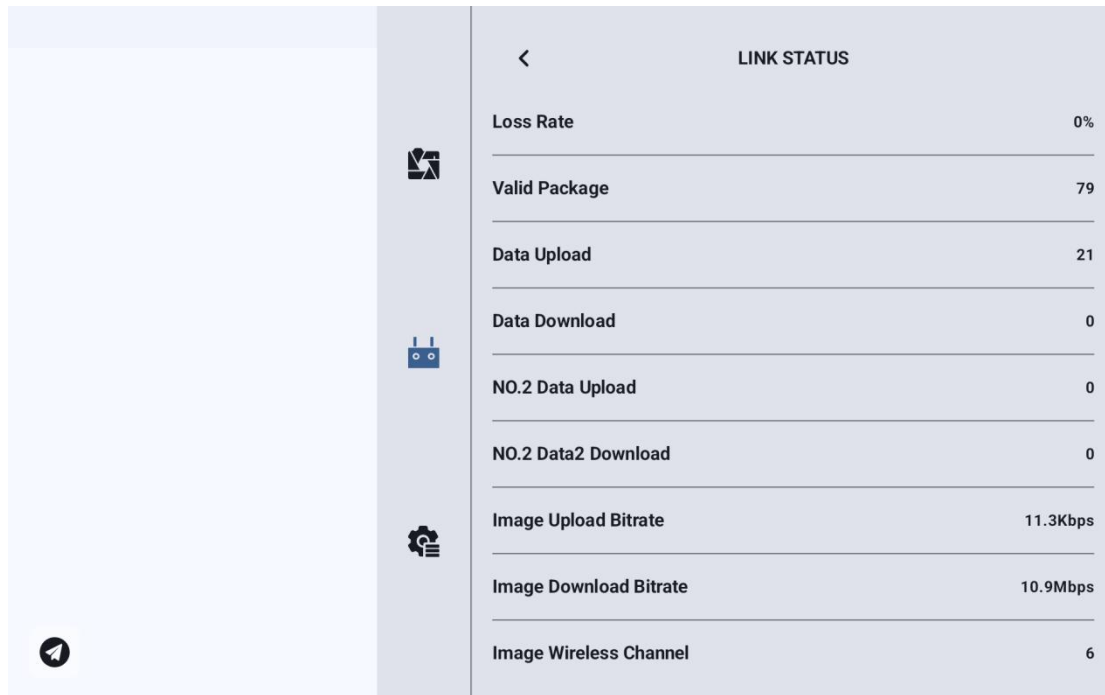

The screenshot shows a mobile application interface for 'LINK STATUS'. The page has a light blue header with a back arrow and the title 'LINK STATUS'. A vertical sidebar on the left contains three icons: a camera, a USB port, and a gear. The main content area displays a list of metrics with their values on the right, separated by horizontal lines. A home indicator is visible at the bottom left.

Metric	Value
Loss Rate	0%
Valid Package	79
Data Upload	21
Data Download	0
NO.2 Data Upload	0
NO.2 Data2 Download	0
Image Upload Bitrate	11.3Kbps
Image Download Bitrate	10.9Mbps
Image Wireless Channel	6

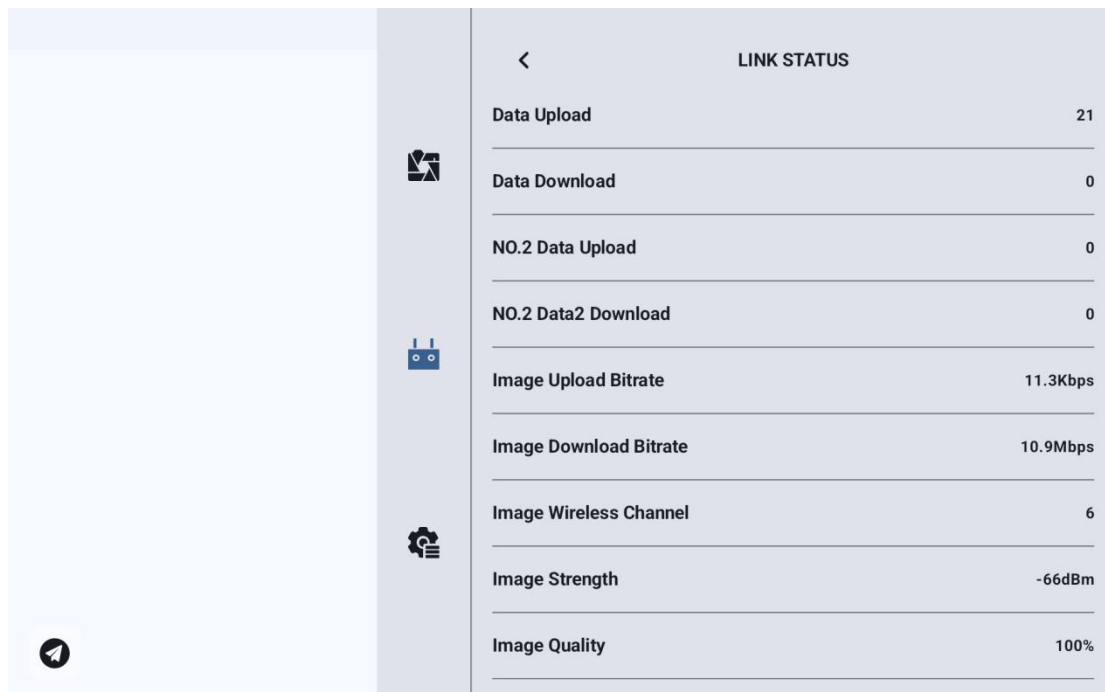

This screenshot shows the same 'LINK STATUS' page as above, but with additional metrics displayed at the bottom. The layout and sidebar are identical. The new metrics are 'Image Strength' and 'Image Quality'.

Metric	Value
Data Upload	21
Data Download	0
NO.2 Data Upload	0
NO.2 Data2 Download	0
Image Upload Bitrate	11.3Kbps
Image Download Bitrate	10.9Mbps
Image Wireless Channel	6
Image Strength	-66dBm
Image Quality	100%

# SIYI

## **Link Information**

### **Packet Loss Rate:**

The number of data packets that fail to return to the ground station per second.

### **Valid Packets:**

The number of data packets successfully received by the ground station per second.

### **Uplink Data Rate:**

The amount of data (in bytes) transmitted from the ground station to the air unit per second.

### **Downlink Data Rate:**

The amount of data (in bytes) transmitted from the air unit to the ground station per second.

### **Image Transmission Uplink Bitrate:**

The amount of image data sent per second through the uplink channel.

### **Image Transmission Downlink Bitrate:**

The amount of image data received per second through the downlink channel.

### **Wireless Channel:**

The current operating frequency point of the image transmission link.

### **Signal Strength:**

The strength of the radio signal between the ground station and the air

# SIYI

unit.

## Signal Quality:

The reliability and stability of the signal transmission between the ground station and the air unit.

## 3.3.6 Button and Dial Settings

The UniRC 7 handheld ground station supports customization of button and dial functionalities.

### 3.3.6.1 Button Configuration

This function allows users to assign specific working modes or actions to the physical buttons on the device.

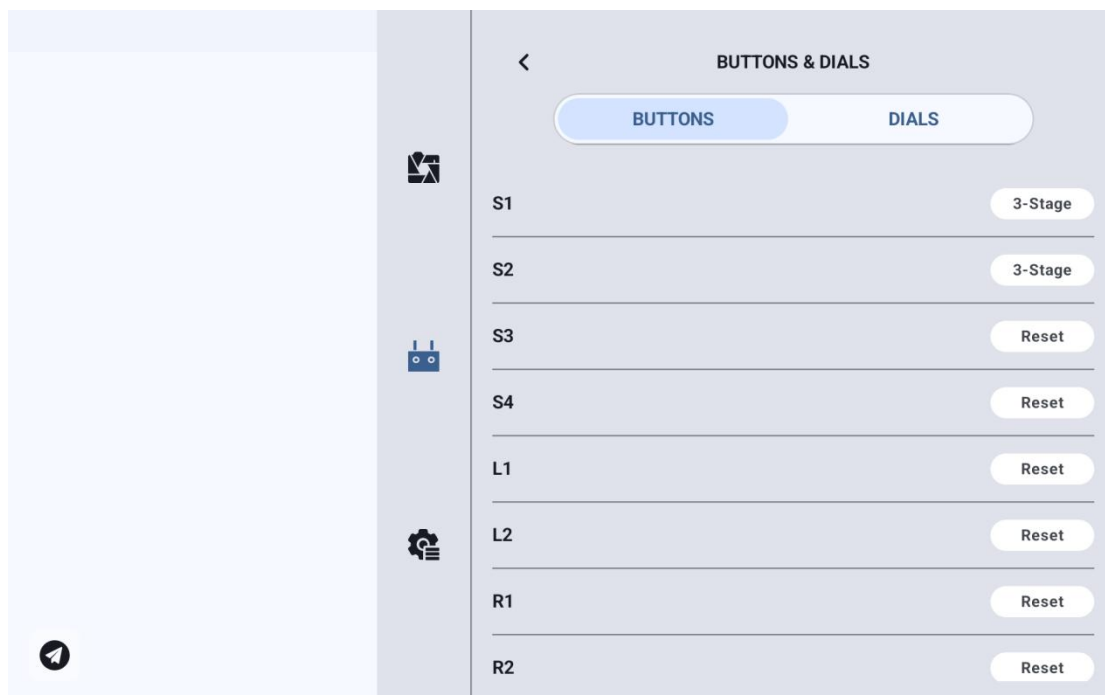

### Button Working Modes

#### Toggle Mode (Self-Locking):

When a toggle button is pressed, it will physically rebound, but the corresponding channel continues to output a signal. The output value switches to 1950. Pressing the button again changes the output to 1050.

# SIYI

## Three-Position Switch Mode:

In this mode, the button functions as a three-position switch. A short press toggles the channel output between 1950 and 1050, while a long press sets the output to 1500.

## Momentary Mode (Non-Self-Locking):

When the button is pressed, the corresponding channel outputs a signal. Once released, the output resets to zero.

### 3.3.6.2 Dial Configuration

This feature allows users to configure the working modes of the LD (Left Dial) and RD (Right Dial) for customized channel control.

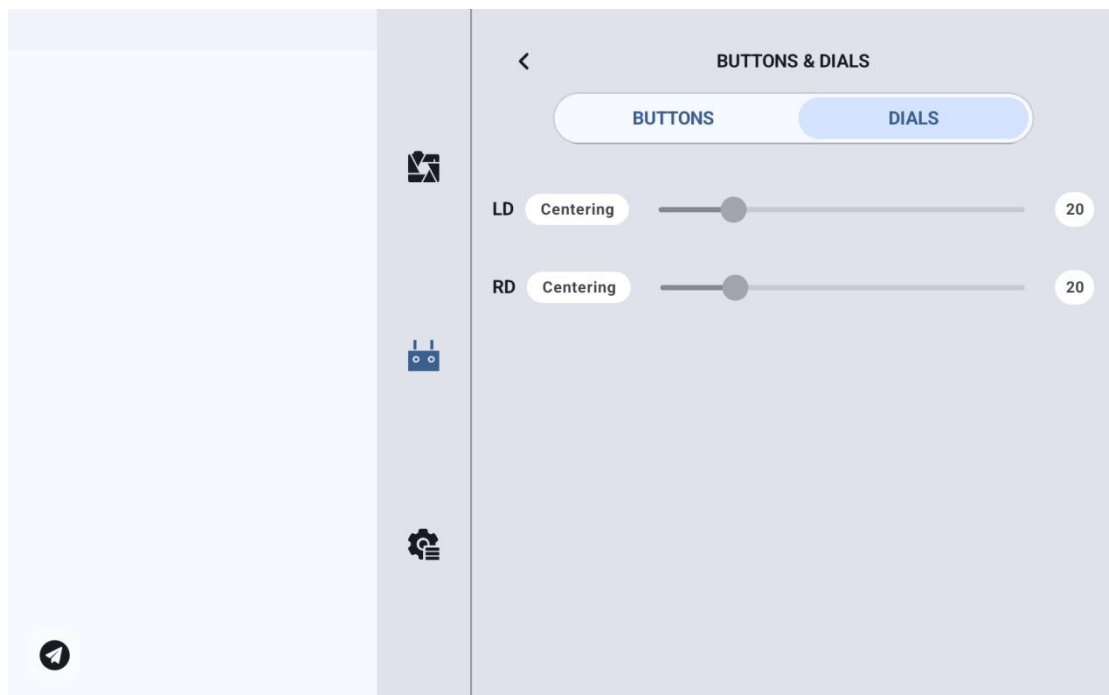

## Dial Working Modes

### Auto-Centering:

In Auto-Centering mode, when the dial is turned and then released, the channel output value will automatically return to the initial position (channel midpoint).

# SIYI

## Non-Auto-Centering:

In Non-Auto-Centering mode, when the dial is turned and then released, the output value will remain at the current channel position and will not return to the center.

### 3.3.7 Receiver Settings

This function allows mapping of five communication channels to the corresponding PWM output ports on the air unit.

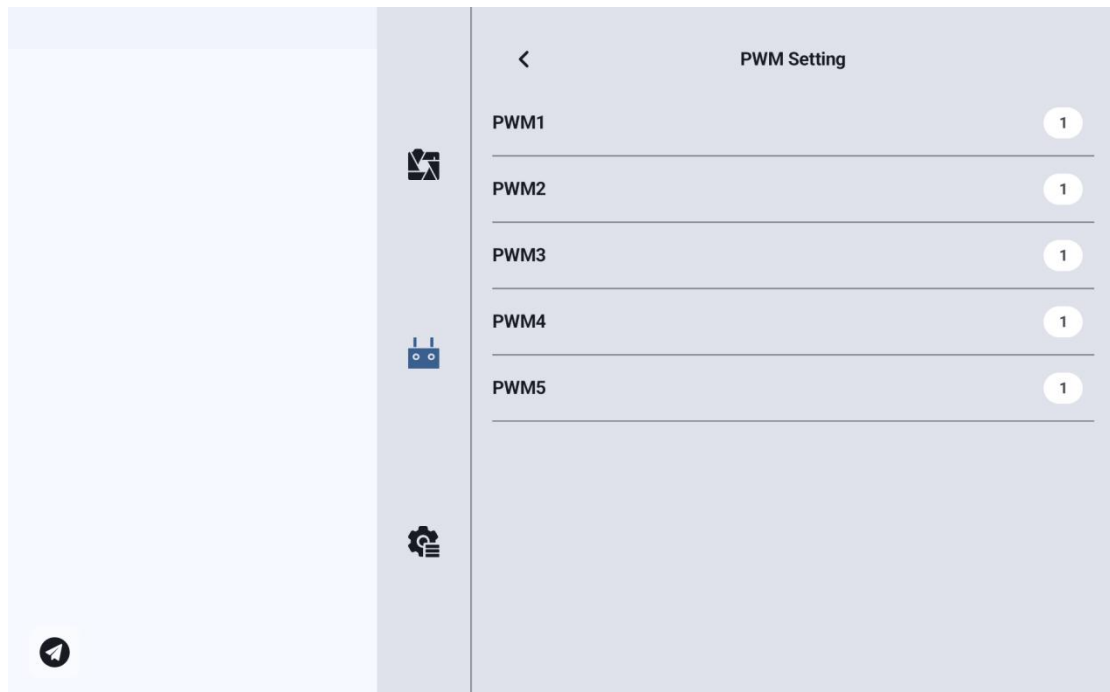

### 3.3.8 Failsafe Settings

After the ground control station and the air unit are paired for the first time, it is essential to configure the failsafe function.

# SIYI

Failsafe refers to the feature that allows the air unit to continue outputting preset PWM values through its channels in the event of a lost connection with the ground station, thereby minimizing the risk of a crash.

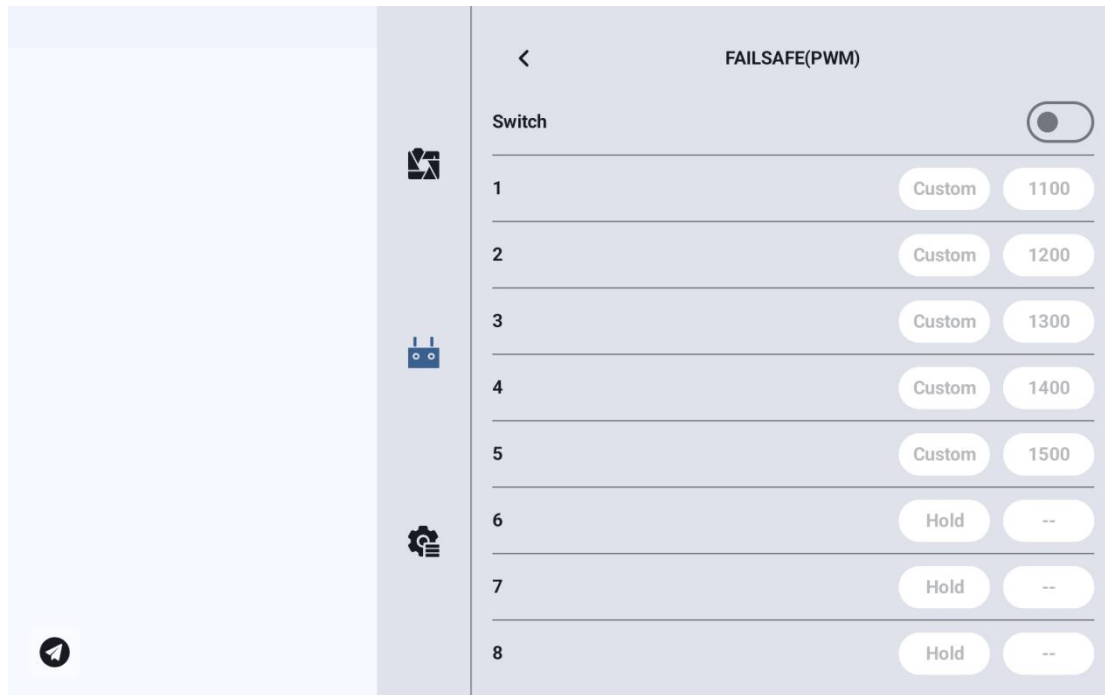

To configure the Failsafe Function for your handheld ground station, please follow the steps below:

1. Ensure that the Ground Control Station (GCS) has been successfully bonded with the Air Unit.
2. Enter the Failsafe Settings menu. The interface will appear as shown below:

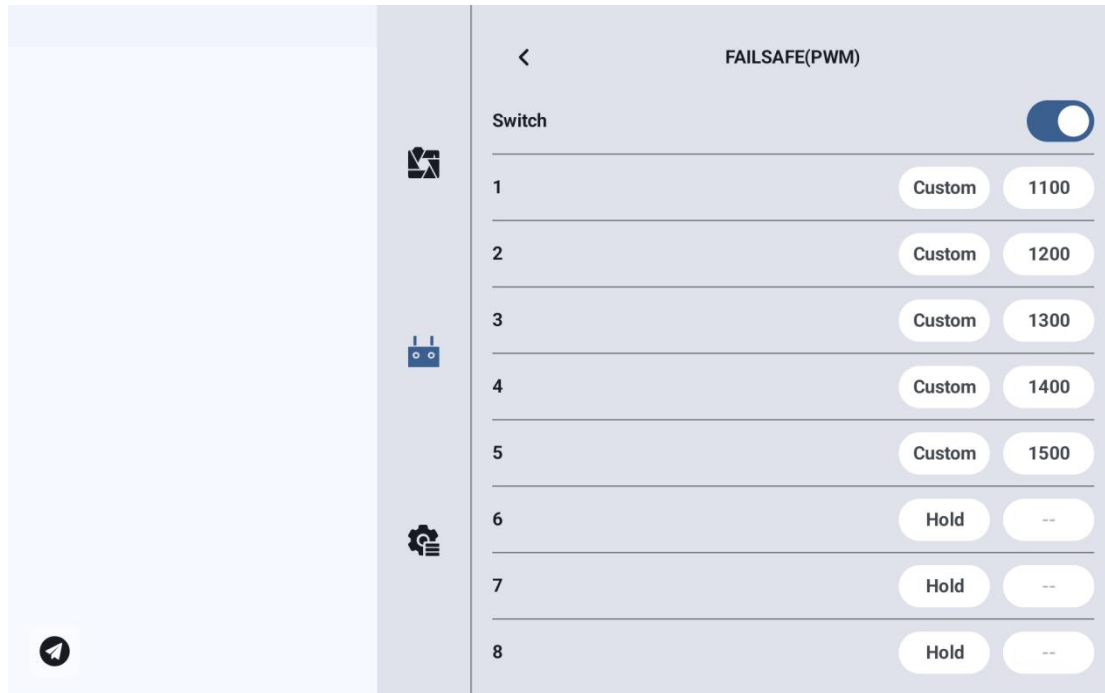

3. The Failsafe Function is disabled by default. The numbers on the left represent the communication channels. When a failsafe output value is not configured, the channel output is displayed as "Hold" by default.
4. If you want a specific channel to output a designated value when failsafe is triggered, first enable the Failsafe Switch. Then click the "Hold" button next to the corresponding channel to switch it to "Custom" mode, and enter the desired output value (travel position).
5. Once the setup is complete, if the link is lost, the selected channel(s) will output the preset travel value accordingly.

## Note:

If your flight controller communicates with the handheld ground station

# SIYI

via the S.Bus protocol, you generally do not need to configure the failsafe function on the ground station side , unless the flight controller specifically requires a certain channel to maintain a preset value to trigger a failsafe action such as Return-to-Home (RTH).

Instead, you can simply configure the appropriate failsafe behavior in the flight controller's GCS software.

The S.Bus protocol includes a failsafe flag, which informs the flight controller when a failsafe condition has occurred.

## **3.3.9 System Settings**

### **3.3.9.1 Multi Air Unit Support**

The Multi-Air Unit function allows the ground station to store multiple sets of binding information and corresponding channel configuration data for different air units.

Once each air unit has been initially bound to the ground station, users can switch between air units without needing to rebind each time.

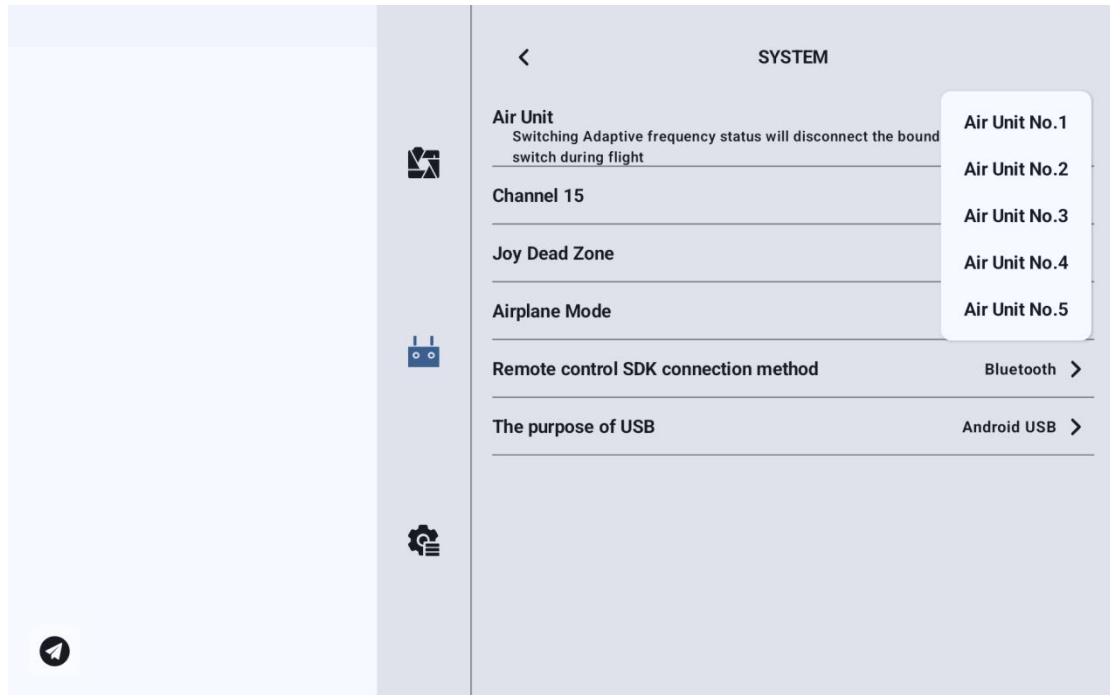

## **Warning**

Never switch the air unit during flight. Doing so may cause loss of link, leading to a loss of control!

### **3.3.9.2 Channel 15 Settings**

This function allows you to assign control of Communication Channel 15 to either the searchlight switch on a weatherproof camera or to the pitch control of the A2mini gimbal.

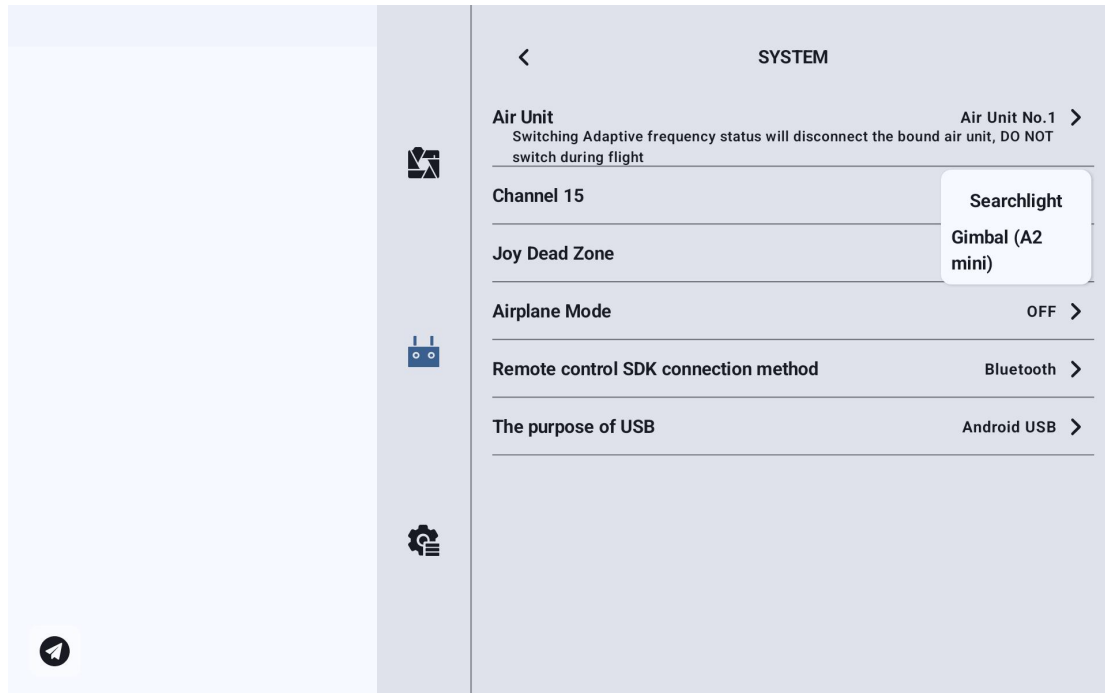

## Note

Channel 15 corresponds to the device connected to the LAN1 port on the air unit, while Channel 16 corresponds to the LAN2 port. By default, Channel 16 controls the floodlight.

The PWM signal from the LAN1 port is segmented (two-stage), while the LAN2 port outputs a linear PWM signal. Therefore, when only the A2mini gimbal camera is connected, ensure that it is connected to the LAN1 port, and set Channel 15 to “Single-Axis Gimbal Mode”.

If the A2mini is connected to the LAN2 port, gimbal control will not be functional.

# SIYI

## 3.3.9.3 Joystick deadzone

Adjust the Joystick deadzone to accommodate different control preferences and handling styles.

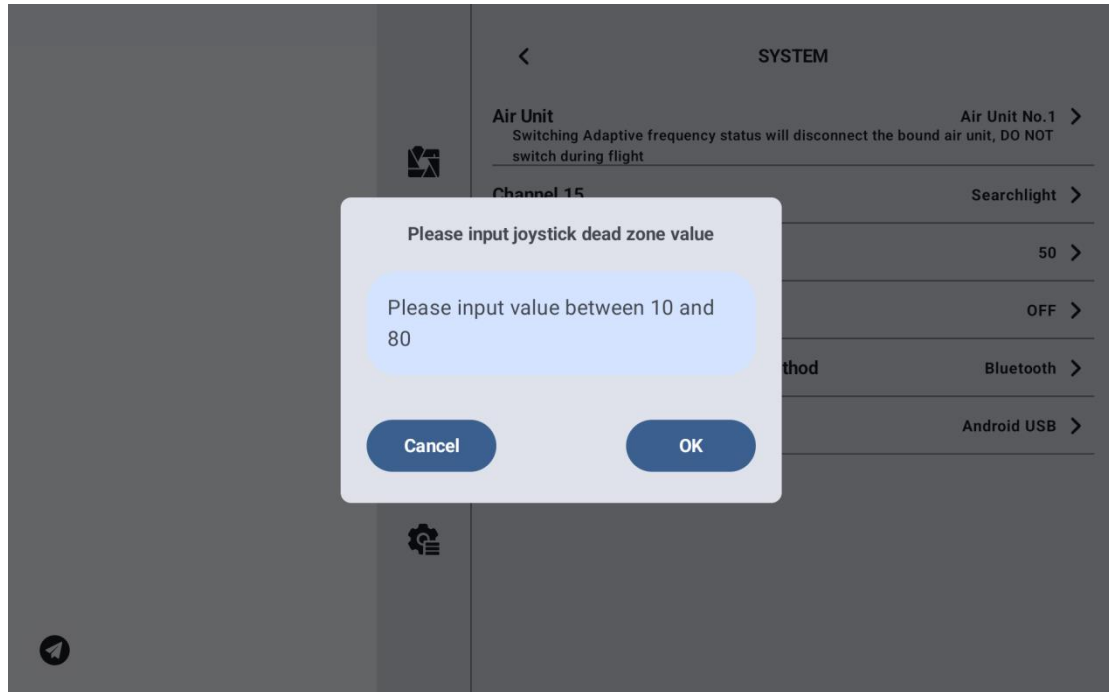

# SIYI

## 3.3.9.4 Flight Mode

The flight mode can be set to 3-position mode, 6-position mode, or turned off.

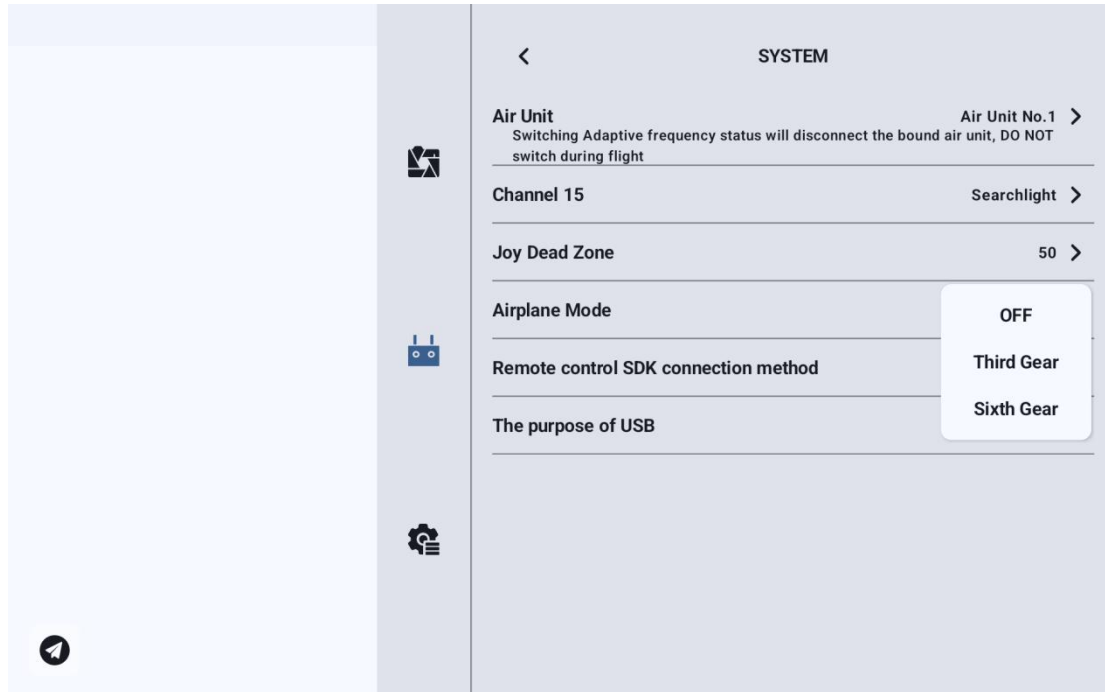

Off: Disables the flight mode function.

3-Position Mode: Buttons M1 to M3 are mapped to a single channel. Pressing M1 sets the channel output to 1050, M2 sets it to 1500, and M3 sets it to 1950.

6-Position Mode: Buttons M1 to M6 are mapped to a single channel. Pressing M1 sets the channel output to 1000, M2 to 1250, M3 to 1425, M4 to 1575, M5 to 1700, and M6 to 2000.

## 3.3.9.5 Flight Channel

The communication channel mapped to the flight mode function.

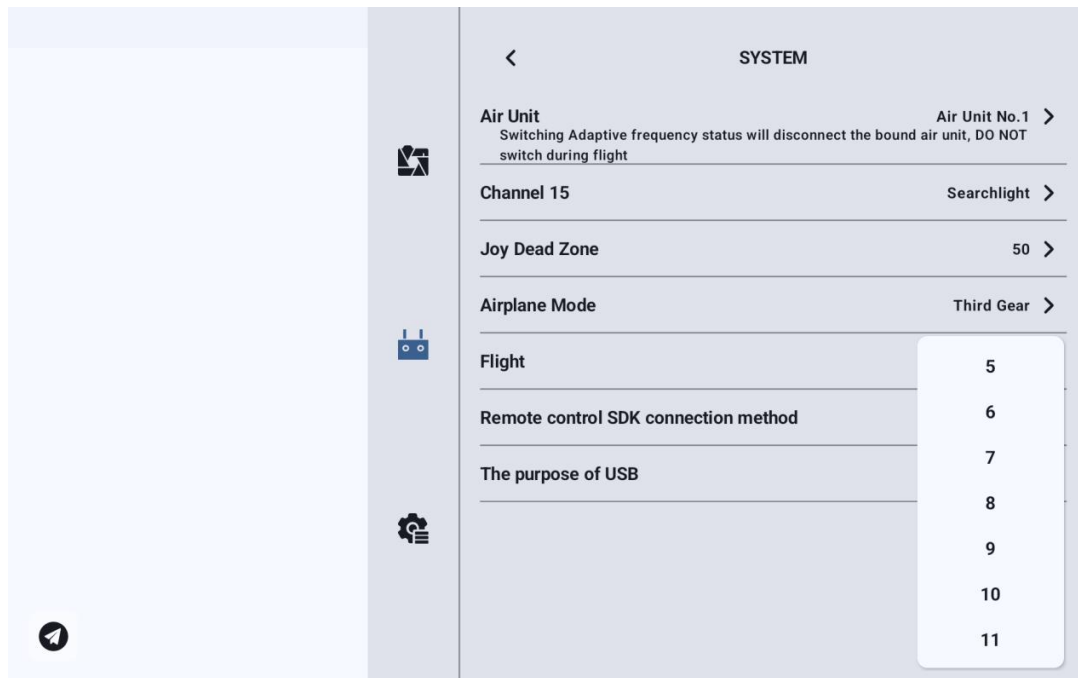

## 3.3.9.6 Remote Control SDK Connection Method

The method by which users connect the data link to their own network and ground station via the SDK.

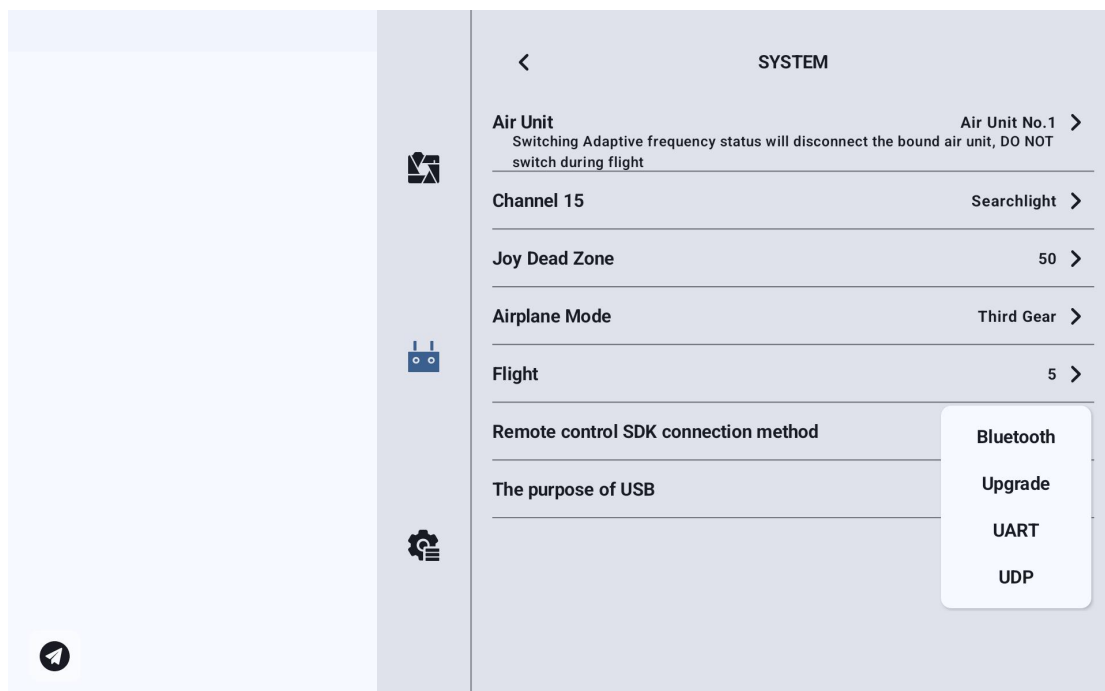

## 3.3.9.7 Remote Controller USB Function

Users can manually switch the working mode of the USB port inside the remote controller.

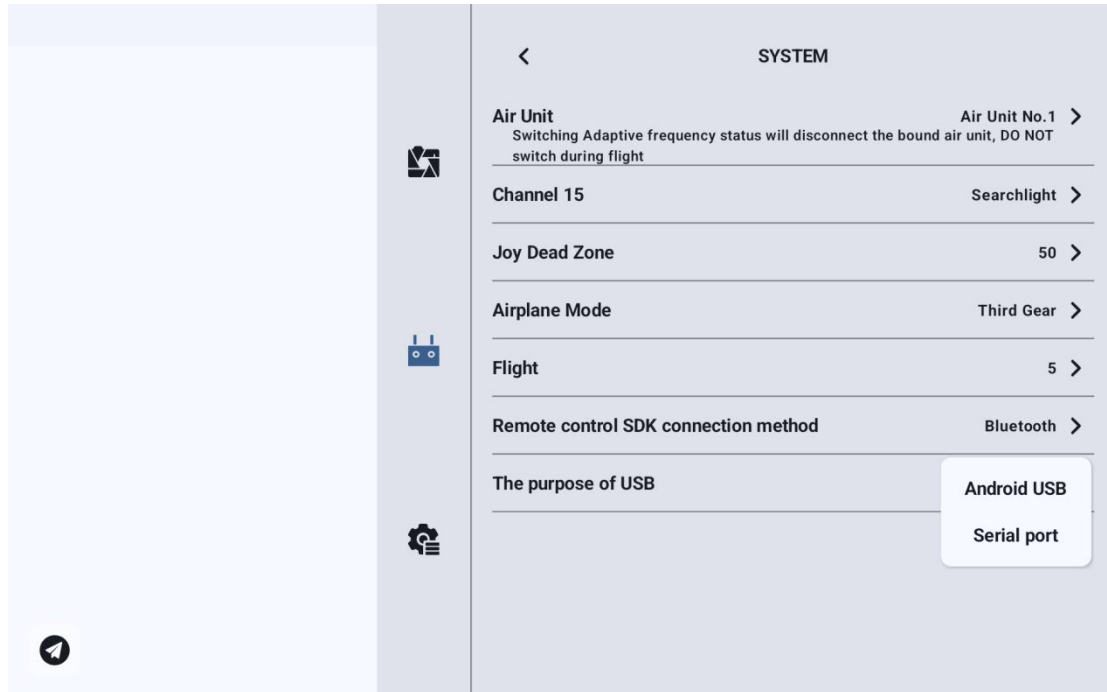

# SIYI

## 3.3.10 Multiple links

### 3.3.10.1 Dual-Control Mode

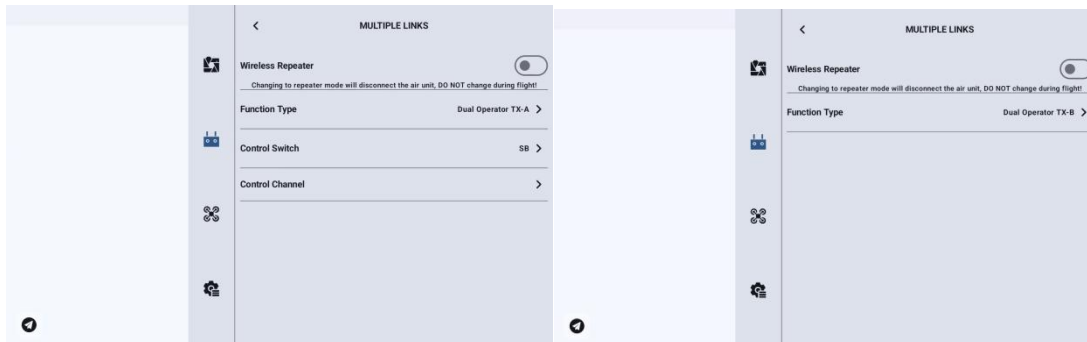
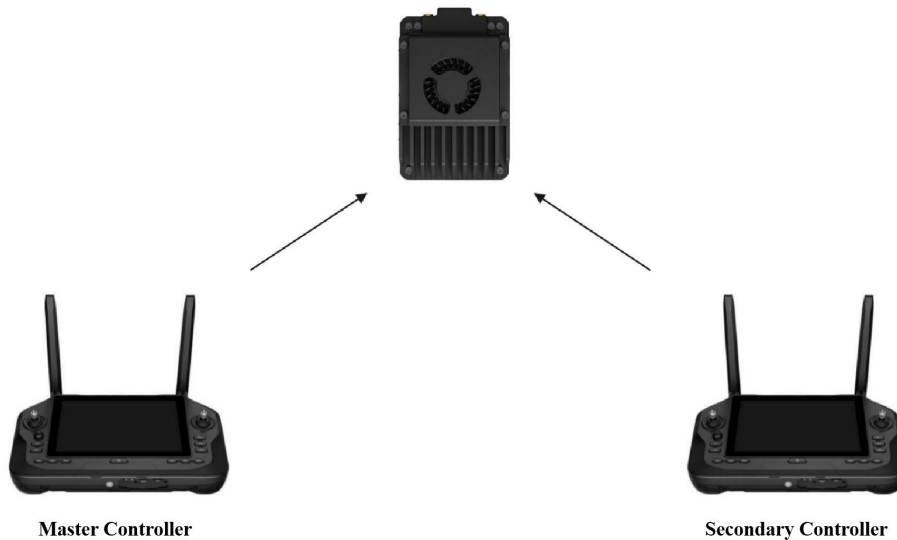

1. First, set the function type of the master controller to “Dual Control - Master” and then pair the master controller with the air unit.
2. Then, set the function type of the secondary controller to “Dual Control - Secondary” and then pair the secondary controller with the air unit.
3. Once pairing is finalized, the master controller can use its exclusive master control switch to transfer control authority of the secondary unit’s

# SIYI

channel to it.

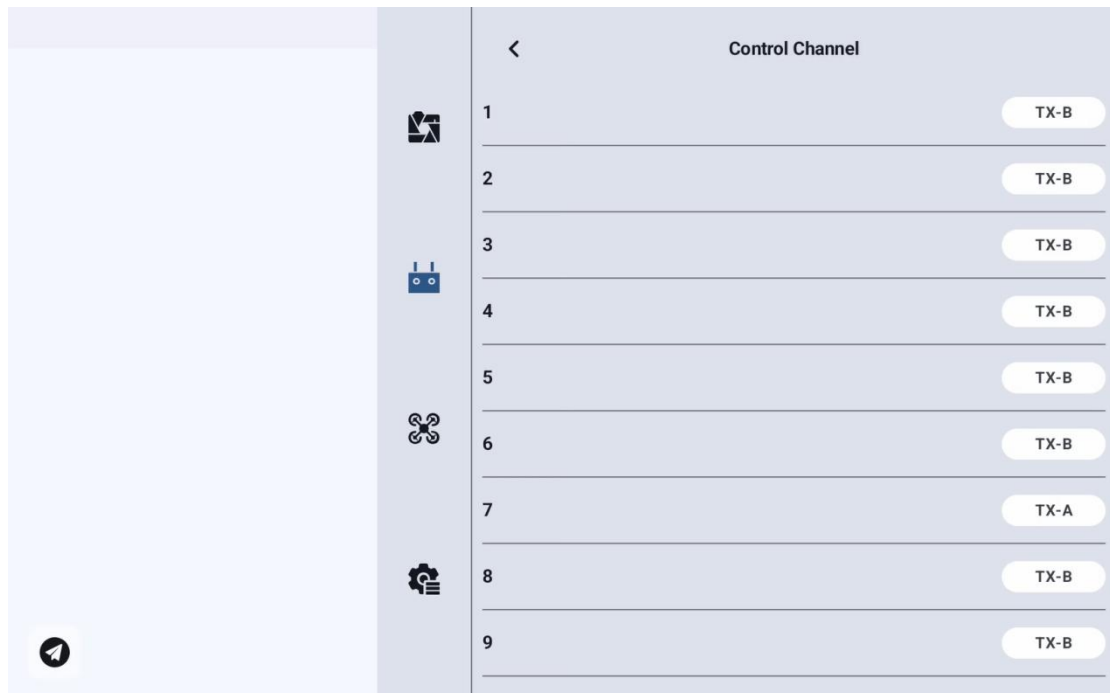

# SIYI

## 3.3.10.2 Remote Relay Mode

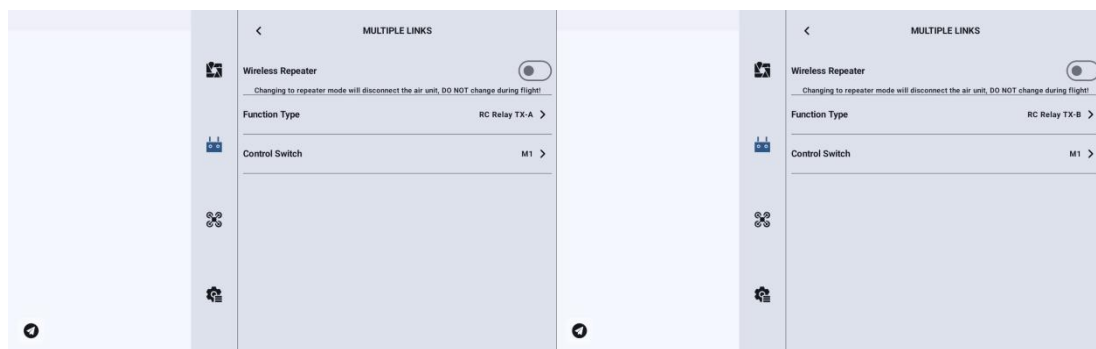
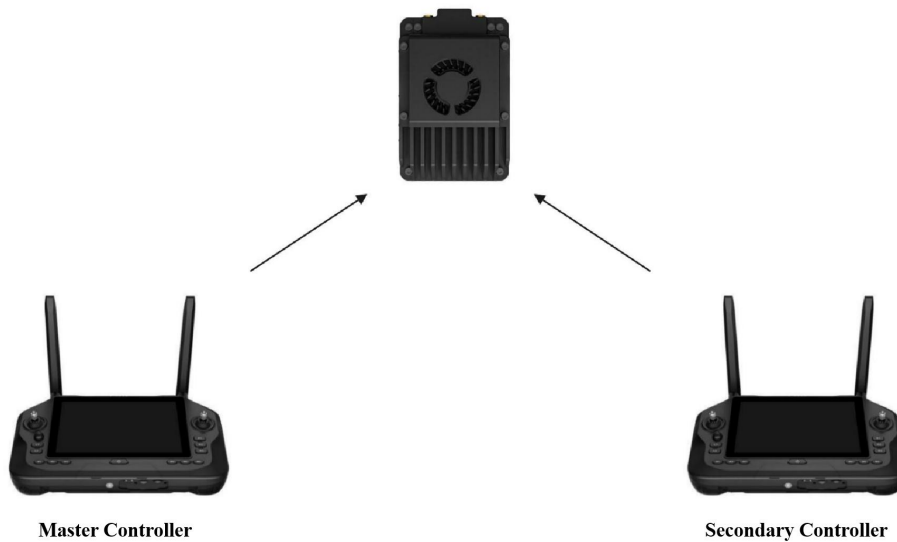

1. First, set the function type of the master controller to “Remote Relay - Master” and then pair the master controller with the air unit.
2. Then, set the function type of the secondary controller to “Remote Relay - Secondary” and then pair the secondary controller with the air unit.
3. After successful pairing, control priority resides with the master controller. The master controller can use its control switch to transfer full control authority to the secondary controller. Once control is switched, the secondary controller can, in turn, use its own control switch to return

# SIYI

full control to the master controller. If either controller loses connection, control is automatically transferred to the other.

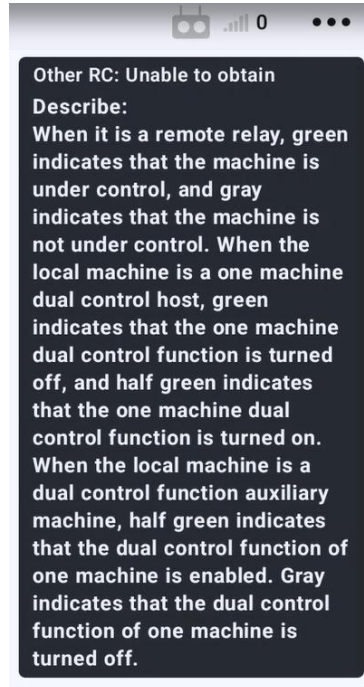

To View the control status, tap the green remote controller icon on the top-right of the UniGCS APP main screen.

# SIYI

## 3.3.10.3 Wireless Relay



1. After enabling the Wireless Relay function, begin by pairing the Relay Unit. To do this, select your pairing target option, then click the pairing button on the controller and press the pairing button on the Relay Unit itself.
2. After a successful pairing, switch the pairing target option to "Air Unit" and proceed to pair it by clicking the pairing button on the controller and pressing the pairing button on the Air Unit.

# SIYI

## 3.3.10.4 Precautions for Multiple Links

1. When switching to the Multiple Links mode, a forced re-pairing will be enforced.
2. Relay function in development, not yet supported.
3. Under either the Remote Relay or Dual-Control mode, the following functions are prohibited from being set on the secondary unit: Data Link Baud Rate, PWM, Failsafe, 15-Channel Mode, and Video Downlink Bandwidth.
4. In Multiple Links mode, configuration of the video transmission mode is prohibited. The mode is fixed to Bitrate Enhancement mode.
5. The wireless channel setting is unavailable in Multiple Links mode and defaults to the Adaptive Wireless Channel mode.
6. For simultaneous video output in UniGCS APP dual-control mode, the following is required: set the master controller's downlink bandwidth to 20M, and enter the RTSP address for the second camera.
7. Frequency band configuration requires synchronization between the master and secondary controllers in Remote Relay and Dual-Control modes. Wireless Relay mode does not support band configuration in this version, as it inherits the band from the ground unit during pairing.
8. Under Remote Relay and Dual-Control modes, the video transmission IP address are configured as follows:

# SIYI

- Secondary Unit: 192.168.144.13
- Master Unit: 192.168.144.12
- Relay Unit: 192.168.144.75

## 3.3.11 Video Transmission Settings

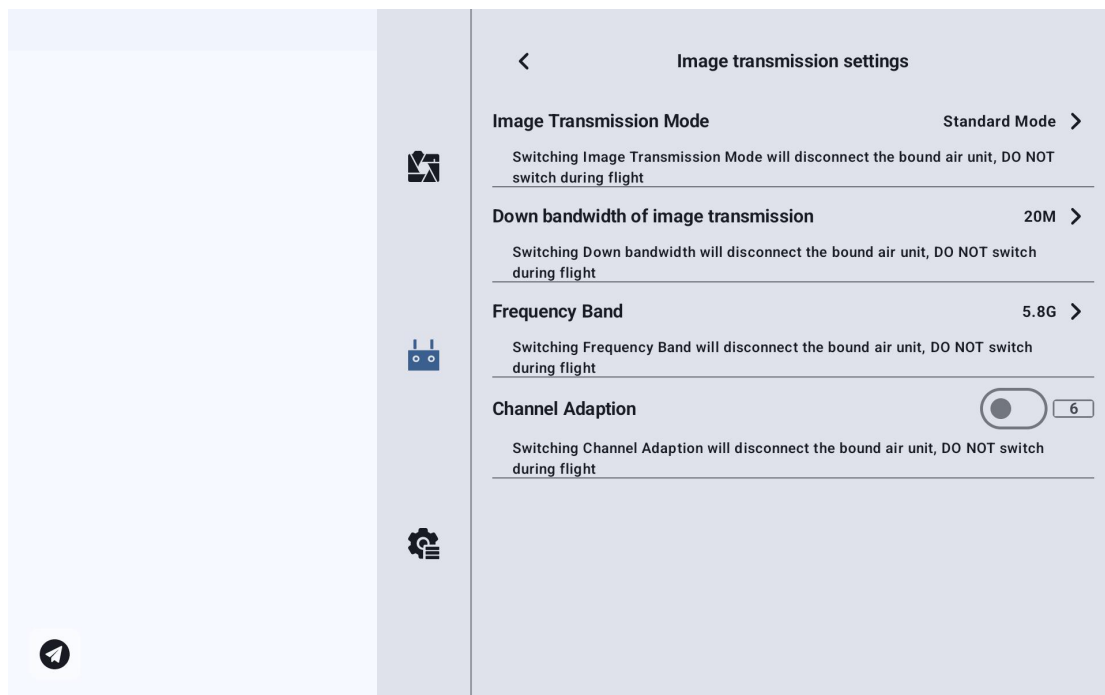

### 3.3.11.1 Video Transmission Mode

Change the bitrate mode of the video transmission.

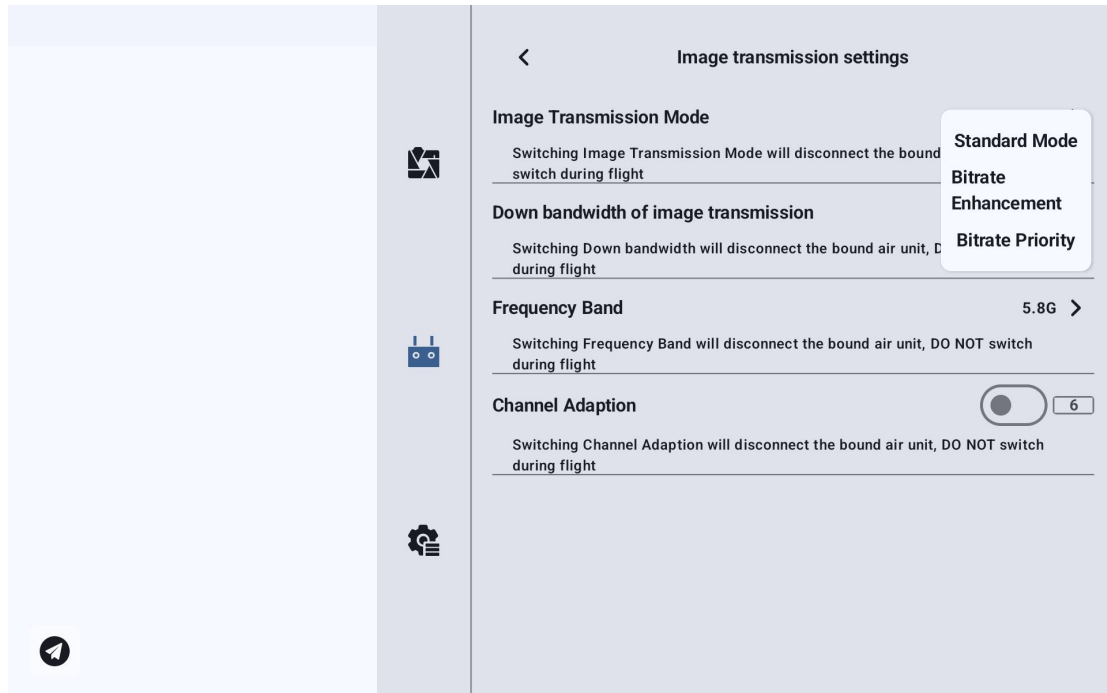

### 3.3.11.2 Downlink Bandwidth

Allows switching the maximum downlink bandwidth of the video transmission. Allows switching the maximum downlink bandwidth of the video transmission.

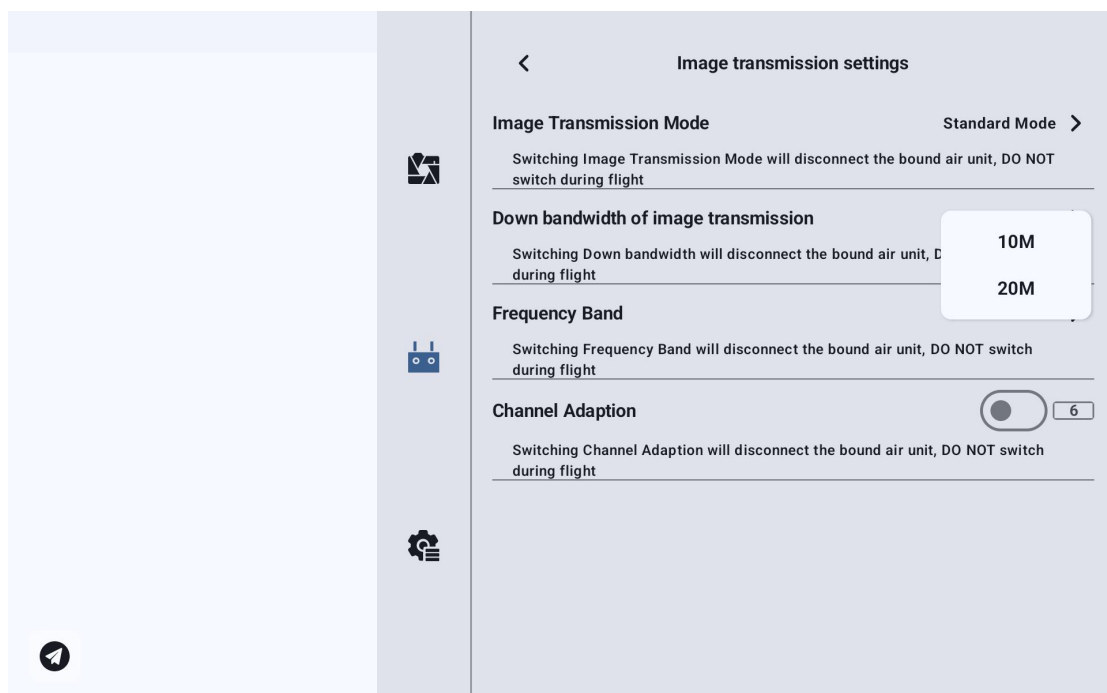

## 3.3.11.3 Operating Frequency Band

Manually switch the frequency band of the remote controller.

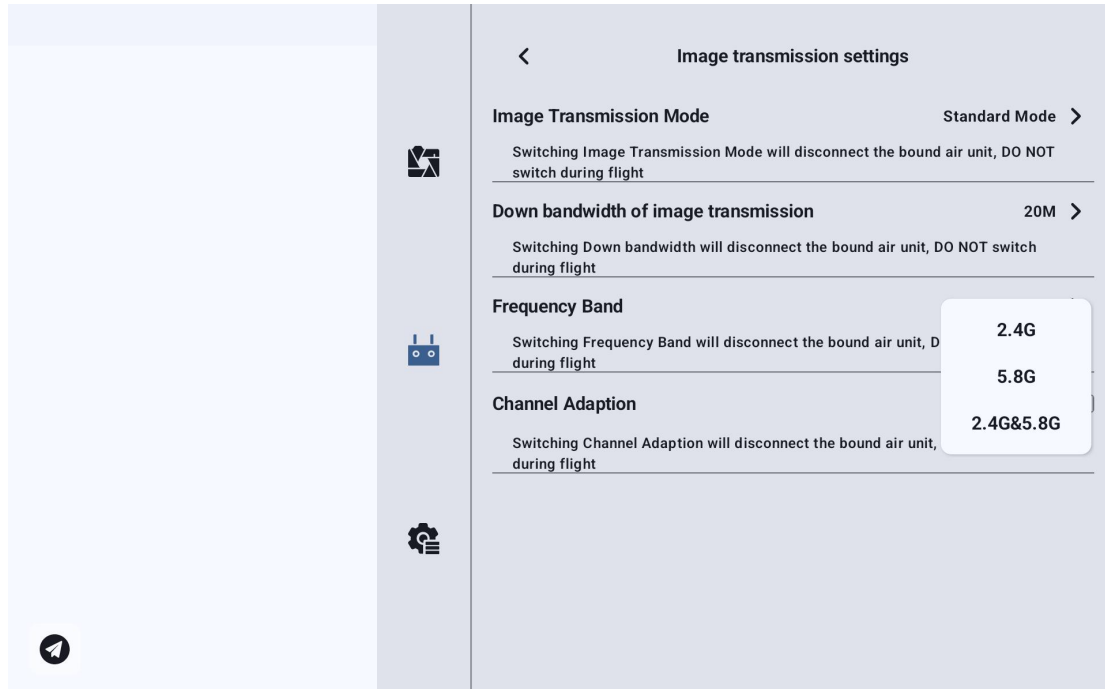

## 3.3.11.4 Adaptive Wireless Channel

In environments with complex electromagnetic interference or noisy wireless signals, enable this feature. When enabled, the SIYI link will automatically search for the wireless channel with the lowest interference during connection establishment to optimize wireless communication conditions.

If Adaptive Wireless Channel is disabled, the wireless channel can be manually selected from channels 1 to 16.

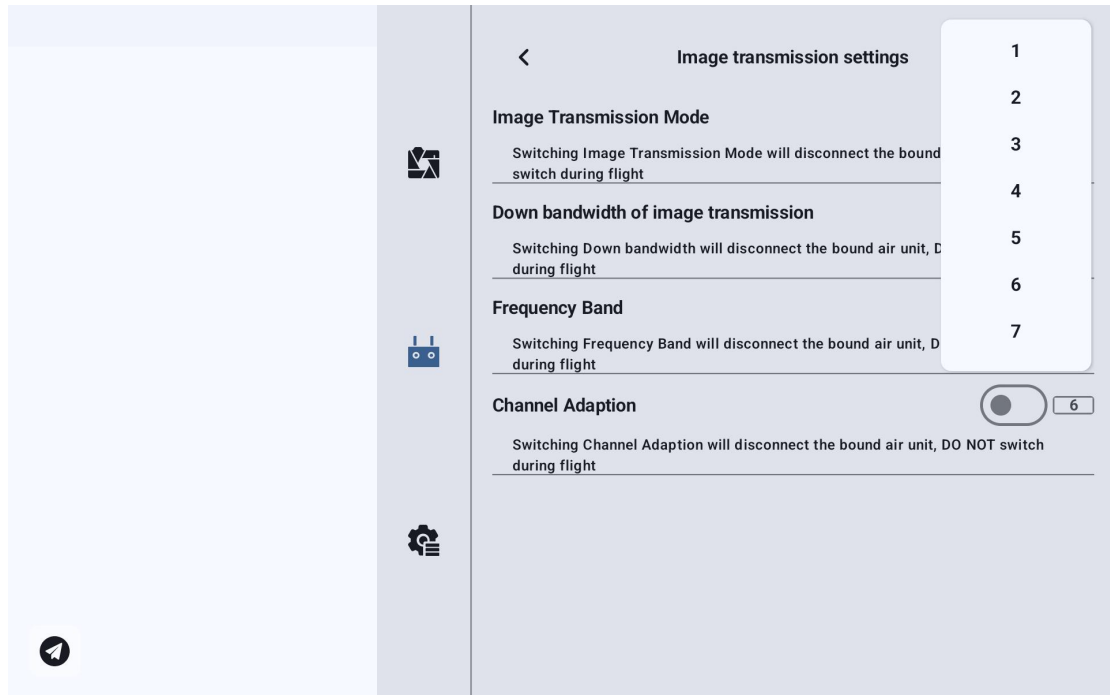

### 3.3.11.5 Device Information

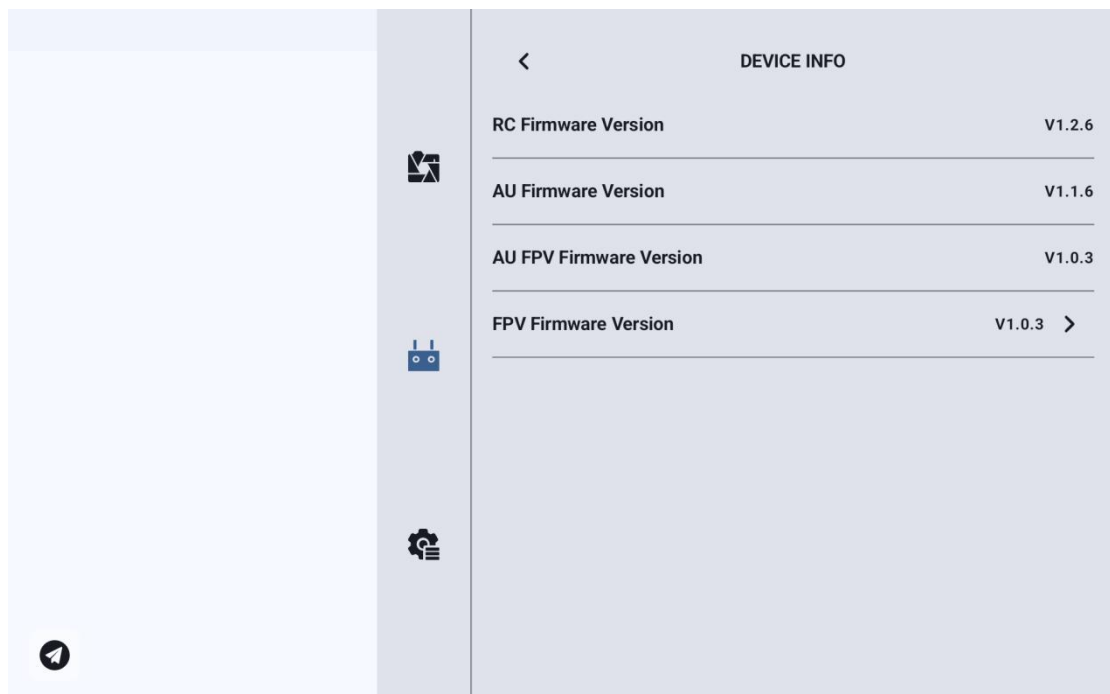

Remote Controller Firmware Version: Current firmware version of the remote controller mainboard.

# SIYI

Air Unit Firmware Version: Current firmware version of the air unit.

AU FPV Firmware: Current firmware version of the air unit's image transmission module.

RC FPV Firmware: Current firmware version of the remote controller's image transmission module.

Clicking on the image transmission firmware version allows manual selection of a local firmware file to upgrade the image transmission firmware on both the air unit and the remote controller.

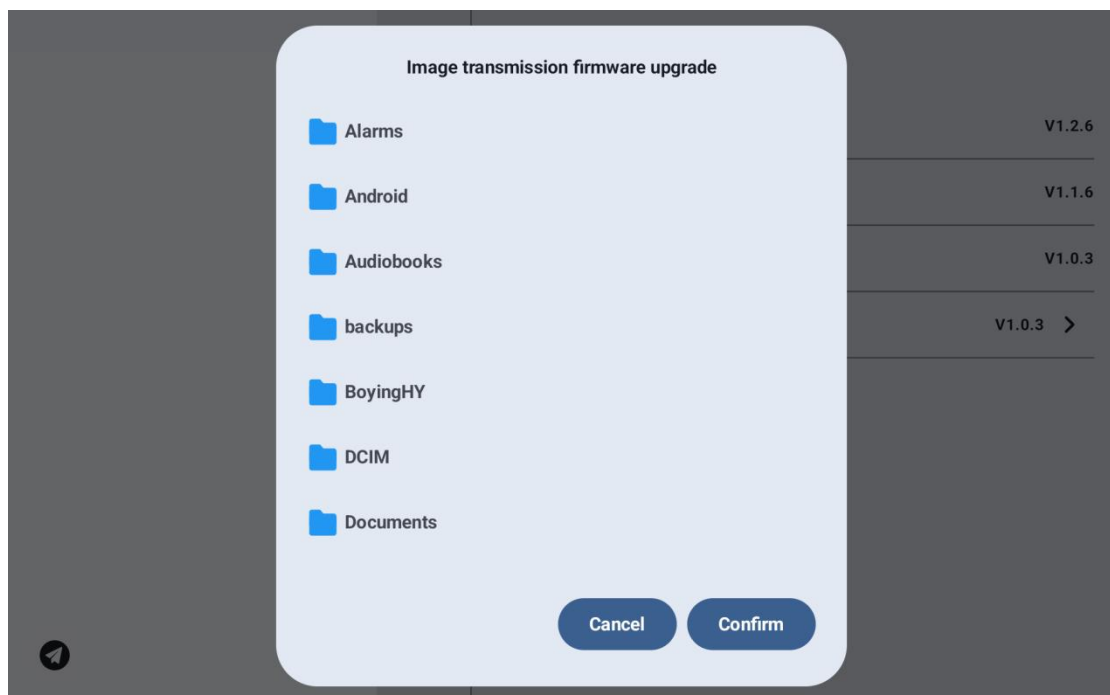

## Note:

The firmware versions of the image transmission modules on both the air unit and the ground station must be consistent to enable communication.

# SIYI

## 3.3.11.6 Binding

Please follow the steps below to bind the Ground Control Station (GCS) and Air Unit:

1. Open the Remote Controller Settings menu in UniGCS, then click “Remote Controller Binding”.
2. The GCS status indicator will start flashing red rapidly, The handheld ground station will emit a beep sound.
3. Press and hold the Air Unit binding button for 2 seconds; the Air Unit status indicator will also start flashing red rapidly.
4. Please wait about 5 to 10 seconds until both the GCS and Air Unit status indicators turn solid green, indicating the binding is successful.

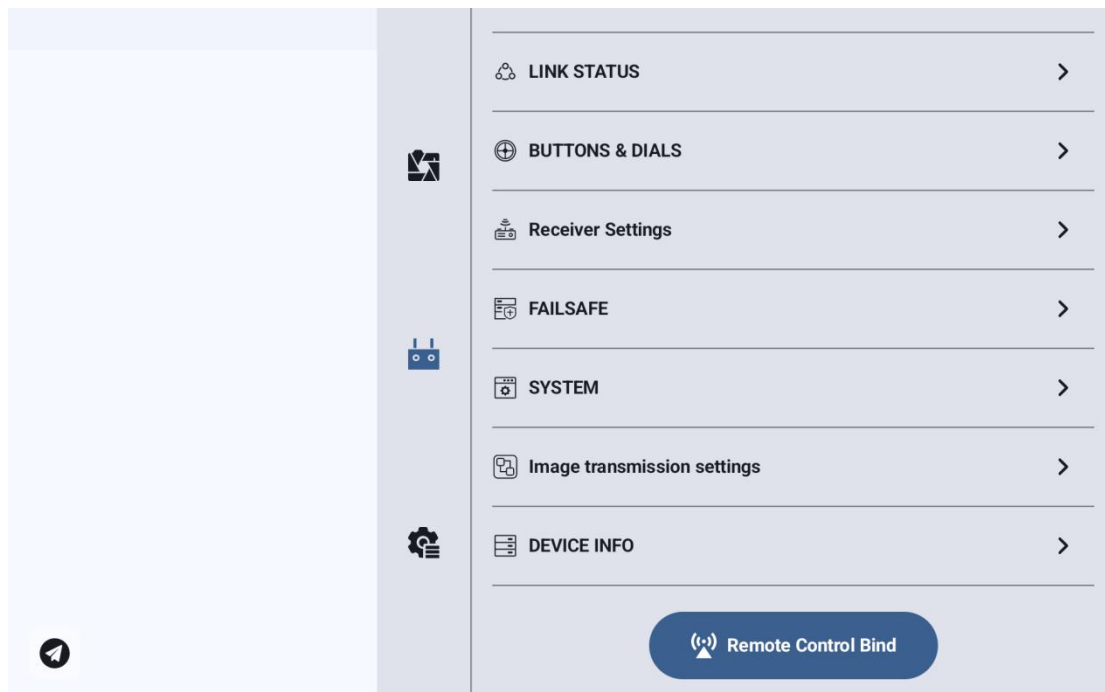

# SIYI

## 3.4 Device Information

Displays the UniGCS application version and commonly used SIYI Technology contact information. You can also switch the map type in this menu.

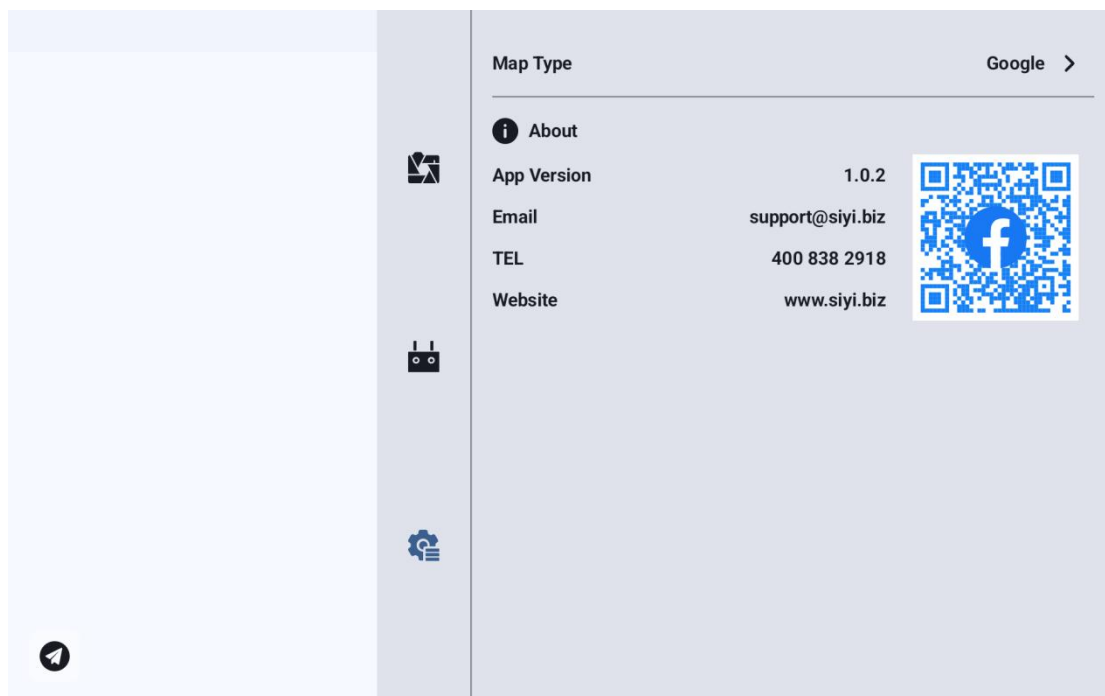

# SIYI

## Chapter 4 Telemetry Data Transmission

Telemetry is one of the core features of most SIYI link products. SIYI link modules and handheld ground stations support communication with various ground control station (GCS) software platforms through multiple hardware and software interfaces.

To enable telemetry, connect the telemetry port of the flight controller to the UART1 or UART2 port on the UniRC 7 air unit.

(The diagram below shows Telemetry Port 1 of the N7 Autopilot connected to the UART1 port of the UniRC 7 air unit.)

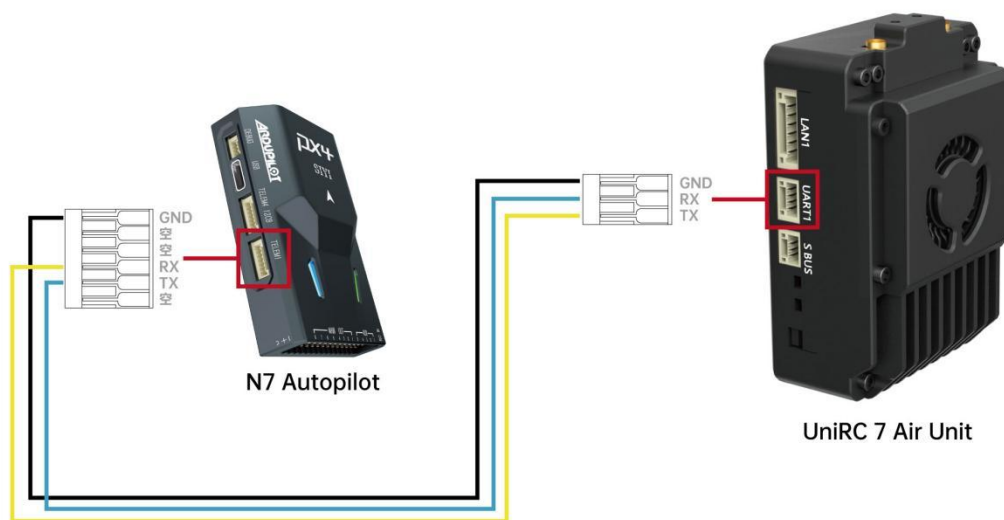

### Note

UniRC 7 supports dual UART ports. When using the telemetry function, please ensure that the configured telemetry port in the ground control software matches the actual UART port connected on the air unit; otherwise, the system may not function properly.

# SIYI

## 4.1 Communication with Android Ground Station via UART

1. Launch the UniGCS app. In the telemetry settings, set the connection type to UART, and configure the baud rate to match the telemetry baud rate of the flight controller.
2. Open the ground control software to establish the connection.



### Note

Developers can refer to the Telemetry SDK documentation in Chapter 6 of this manual to enable support for this feature in their own ground control station applications.

### 4.1.1 BoYing “XUAV”

1. Launch the UniGCS app. In the telemetry settings, set the connection type to UART, and set the air unit baud rate to 57600.
2. Open the XUAV ground station. Set the connection type to Serial Port, the port address to `/dev/ttyHS3`, and the baud rate to 115200. Then, click Connect.

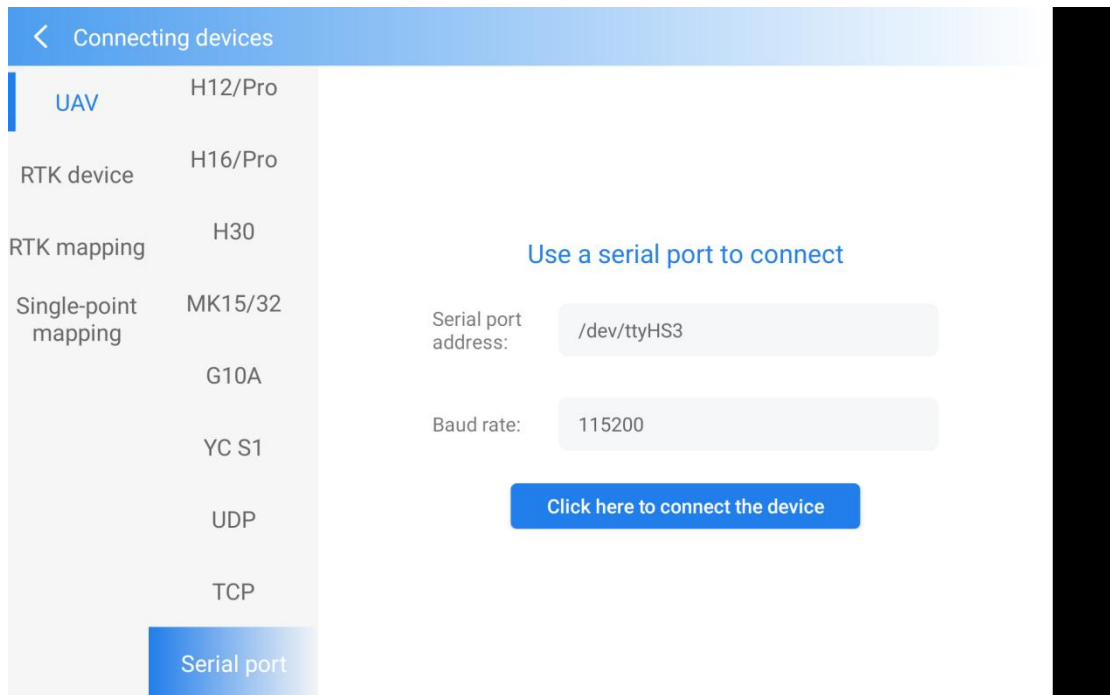

3. Wait for the handheld ground station to connect to the flight controller.

## Note

SIYI link products also support connection to the XUAV ground station via Bluetooth.

## 4.2 Communication with Android Ground Station via Bluetooth

### 4.2.1 QGroundControl

1. Launch the UniGCS app. In the telemetry settings, set the connection type to Bluetooth, and set the air unit baud rate to match the telemetry baud rate of the flight controller.
2. Go to the Bluetooth settings in the Android system menu. Search for the device named "BLUE 94\*\*\*\*\*", and pair with it.
3. Open the QGroundControl (QGC) ground station software. Navigate to Application Settings > Comm Links, click Add to create a new connection, and name it "Bluetooth".

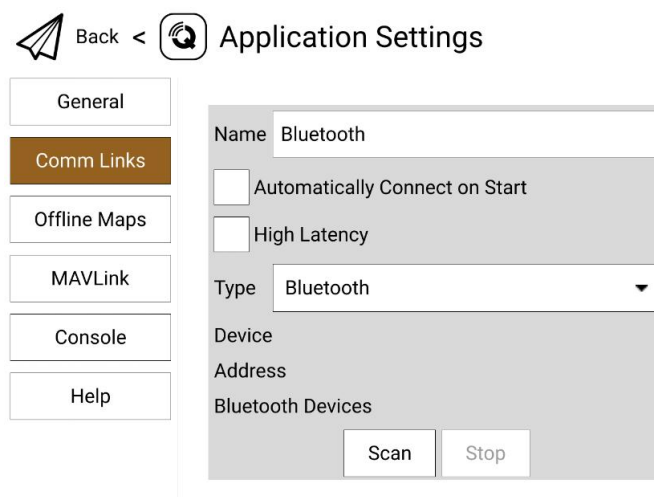

4. Set the connection type to Bluetooth, then click Scan to search for available devices.



5. Select the Bluetooth device named "BLUE-xxxxxxx", then click "OK" to return to the Comm Links menu.

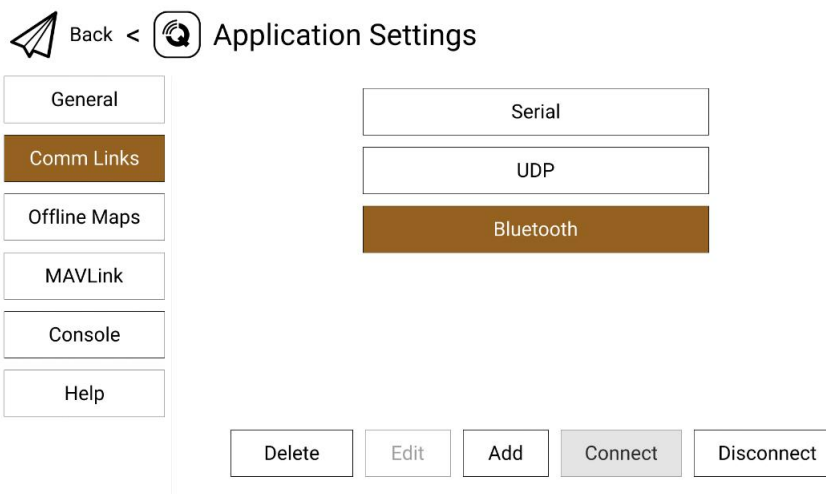

6. Select the configured "Bluetooth" connection and click "Connect".  
Once the progress bar at the top of the QGC interface starts moving, it indicates that the handheld ground station and the flight controller are attempting to establish a telemetry connection. Once connected, data communication will proceed normally.

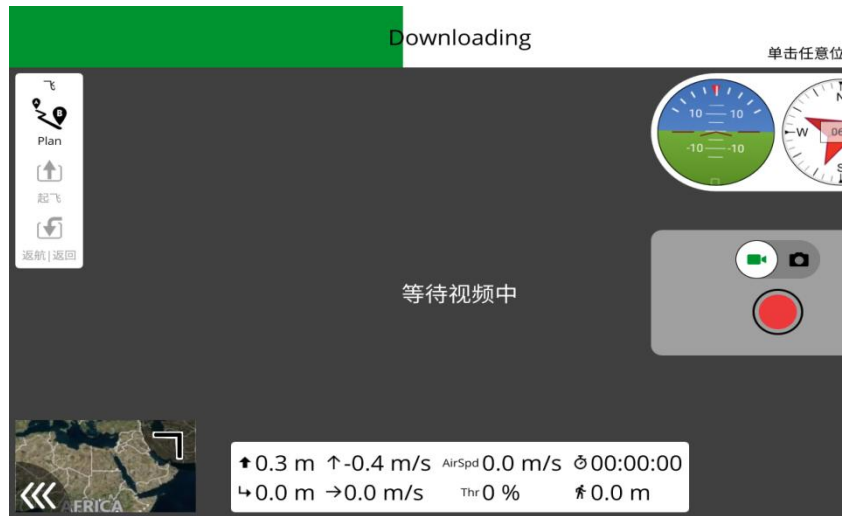

## Note

Steps 1–2 have been pre-configured before shipment.

When adding and setting up the connection in QGroundControl for the first time, do not check the “Automatically Connect on Start” option.

You may enable this option after confirming that the telemetry connection works properly.

# SIYI

## 4.2.2 Mission Planner

1. Open the UniGCS app, go to Telemetry Settings, set the connection type to Bluetooth, and configure the baud rate to match that of the flight controller's telemetry port.
2. Launch the Mission Planner ground control software, select the corresponding COM port (standard serial port assigned to the Bluetooth connection) and baud rate, then click Connect.



3. Wait patiently for the connection to be established.



## 4.2.3 JiYi “AgriFly Assistant”

1. Open the UniGCS app, go to Telemetry Settings, set the connection type to Bluetooth, and configure the baud rate to 57600.

# SIYI

2. In the AgriFly Assistant app, select Bluetooth as the connection method and confirm the selection.

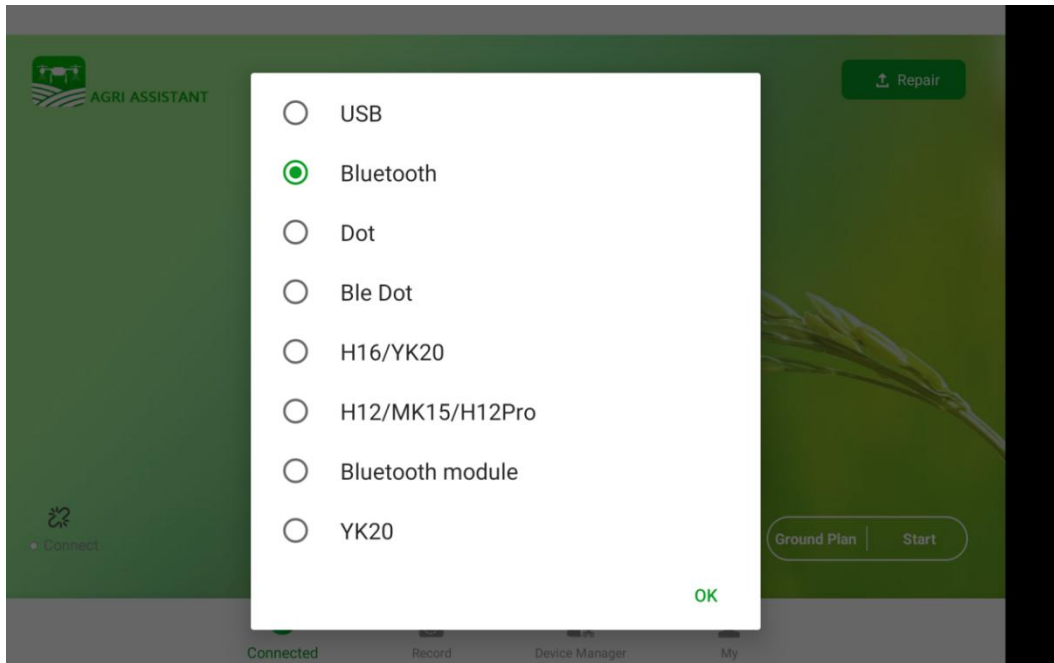

3. Select the remote controller's telemetry Bluetooth device and click Connect.

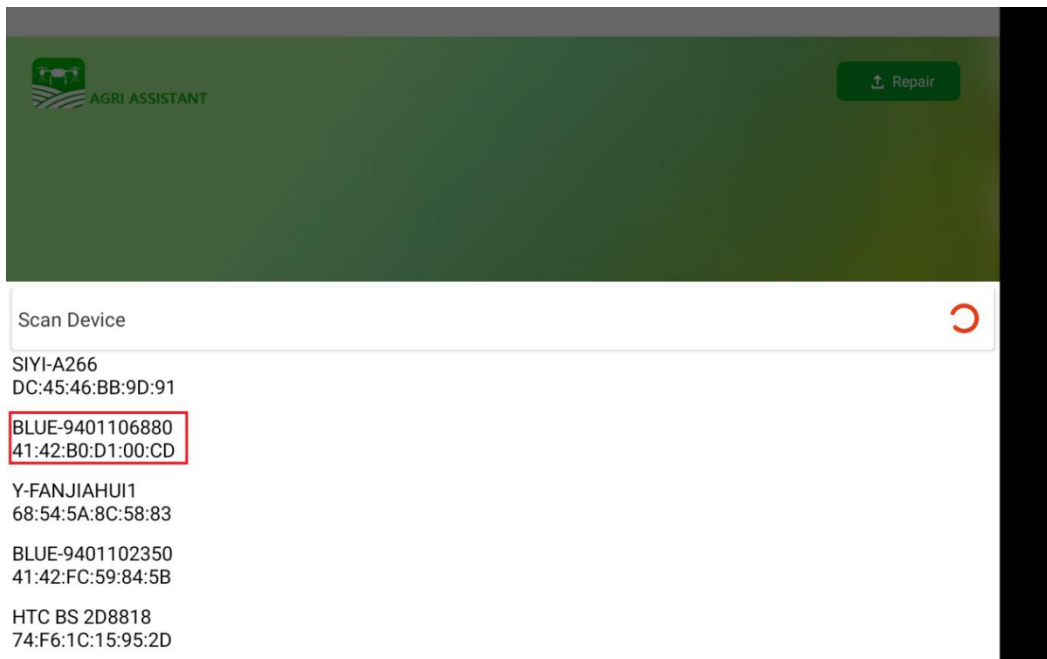

4. Wait patiently for the connection to be established.

## 4.3 Communication with Android Ground Station via UDP

### 4.3.1 QGroundControl

1. Open the UniGCS app, go to Telemetry Settings, set the connection type to UDP, and configure the baud rate to match the telemetry port of the flight controller.
2. Launch the QGroundControl (QGC) ground station software, go to the Application Settings menu, click on Comm Links, and add a new connection by clicking Add, naming it UDP.

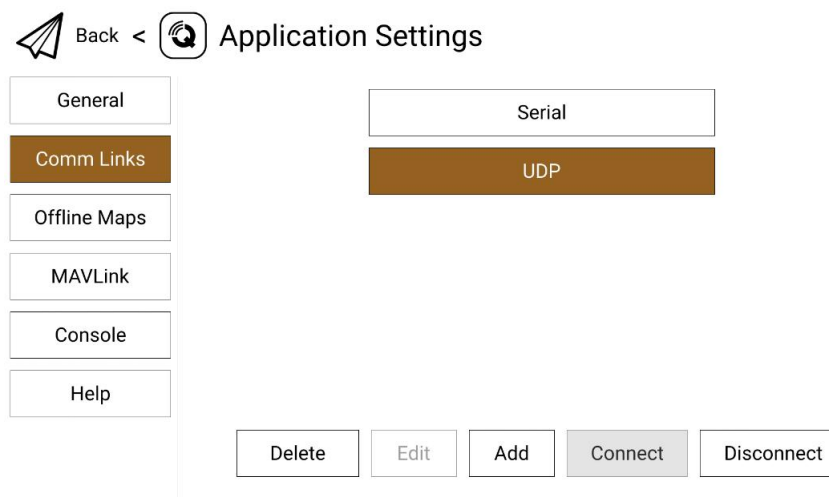

3. Set the connection type to UDP, set the Port to 0, enter the Server Address as 192.168.144.20:19856, add the server by clicking Add Server, then click OK to return to the Comm Links menu.



4. Select the configured “UDP” connection and click “Connect”.When the progress bar at the top of the QGC interface starts moving, it indicates that the handheld ground station and the flight controller ground station software are attempting to establish telemetry communication.Once the connection is established, data communication will proceed normally.

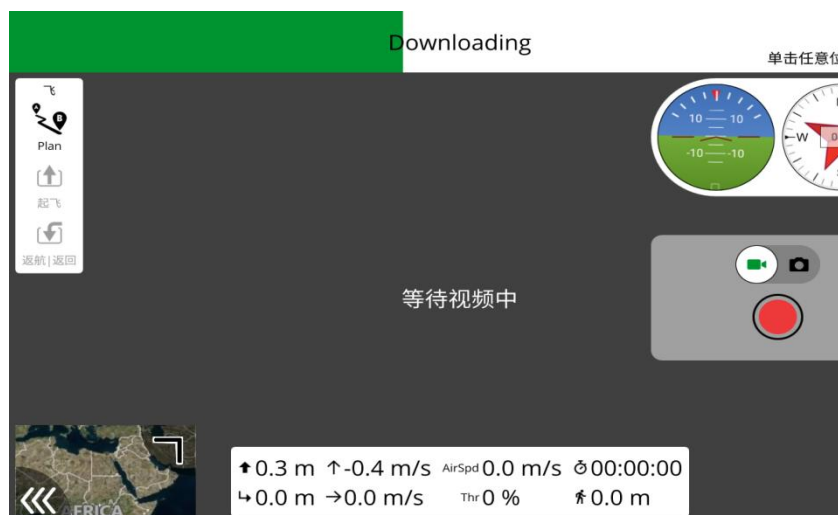



## Note

When adding and configuring the connection for the first time in QGC, do not check the “Automatically Connect on Start” option.

You may enable this option after confirming that the telemetry connection is working properly.

### 4.3.2 Mission Planner

1. Open the UniGCS app, go to Telemetry Settings, set the connection type to UDP, and configure the baud rate to match the telemetry port of the flight controller.
2. Launch the Mission Planner ground station software, select the corresponding port (UDPCI) and baud rate, set the Port to 19856, enter the Server Address as 192.168.144.20, then click Connect to establish the connection.

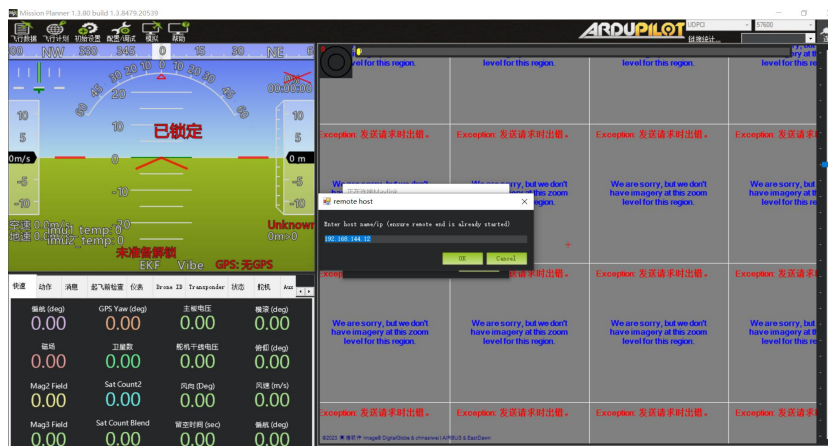

# SIYI

3. Wait patiently for the connection to be established.



## 4.3.3 VGCS Ground Station

1. Open the SIYI Remote Control app, go to Telemetry Settings, set the connection type to UDP, and change the baud rate to 115200.
2. Open the connection options and add a new connection.

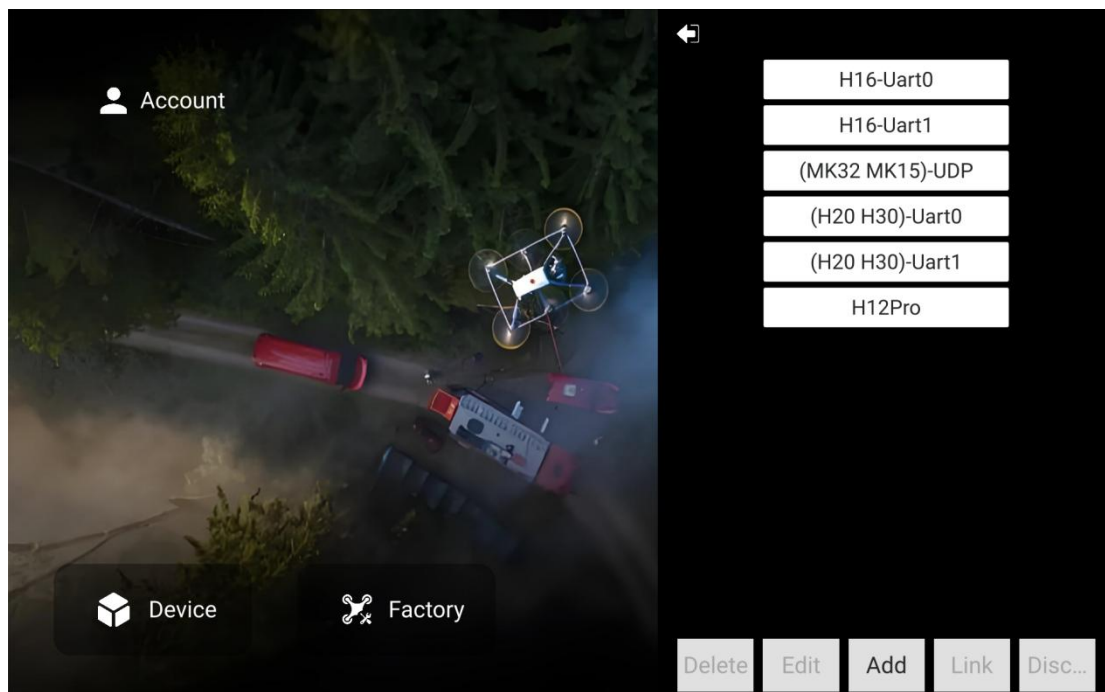

3. Select the connection type as UDP, enter 192.168.144.20:19856 in the server address field and add the server, then change the port to 0.

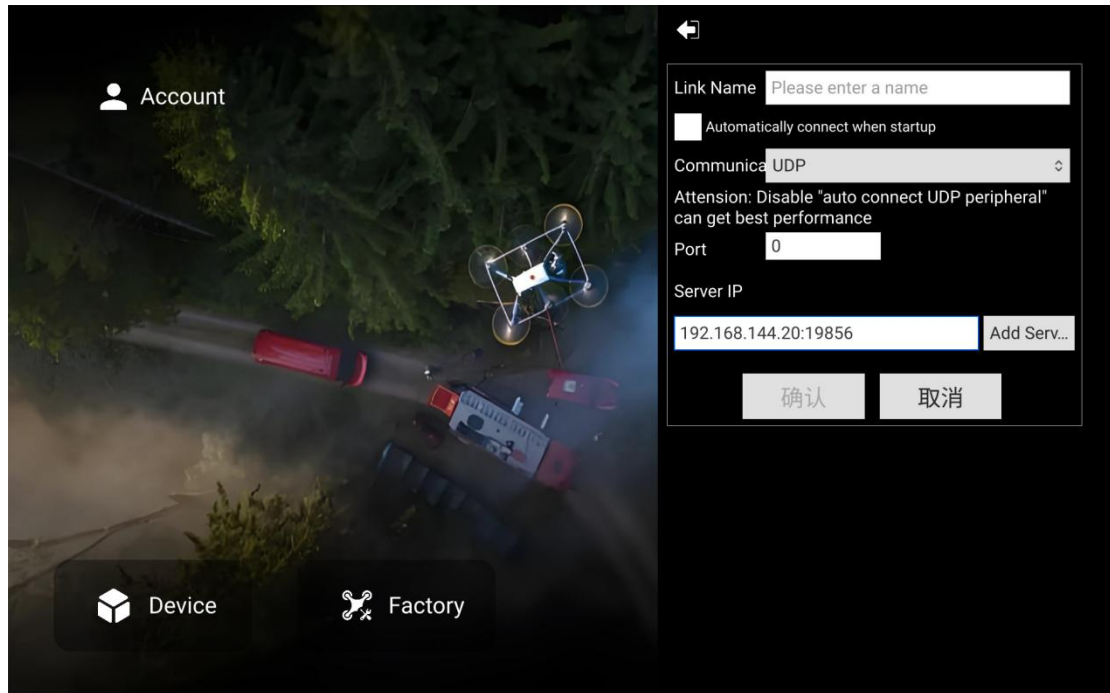

4. Save the connection settings and connect.

## Note:

SIYI Link also supports connection to the VGCS ground station via Bluetooth.

## 4.4 Communication with Windows Ground Station via Ground Unit Type-C Upgrade Port

### 4.4.1 QGroundControl

1. Use the original upgrade cable to connect the Type-C upgrade port at the bottom of the ground unit to the PC. The PC will create a communication port for the ground unit.
2. Open the UniGCS app, go to Telemetry Settings, set the connection type to Upgrade, and set the baud rate to match the telemetry port of the flight controller.

# SIYI

3. Launch the QGC ground station software, navigate to Application Settings, click Comm Links, then add a new connection named Upgrade / Type-C.

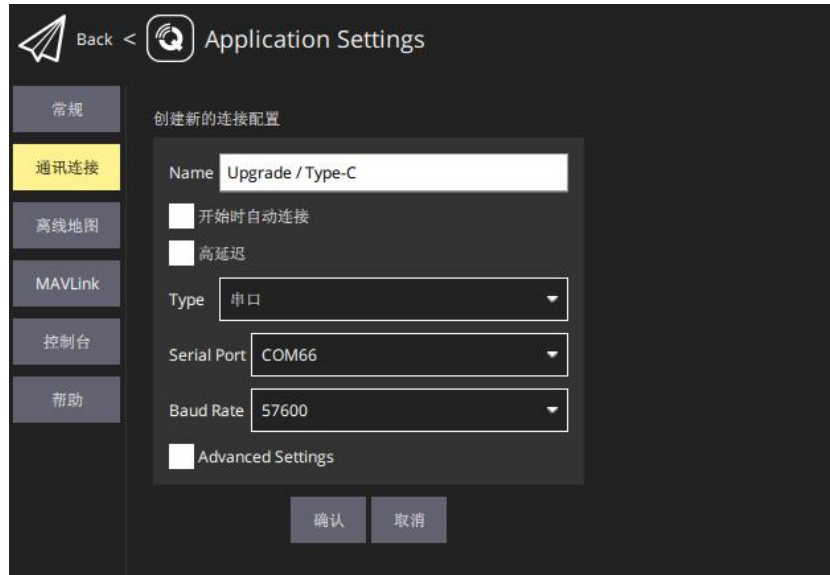

4. Set the connection type to Serial, then select the corresponding port and baud rate.
5. Choose the configured Upgrade / Type-C connection and click Connect. When the progress bar at the top of the QGC ground station changes, it indicates that the telemetry communication between the ground unit and the ground station has entered the auto-connection process. Once connected, normal communication is established.

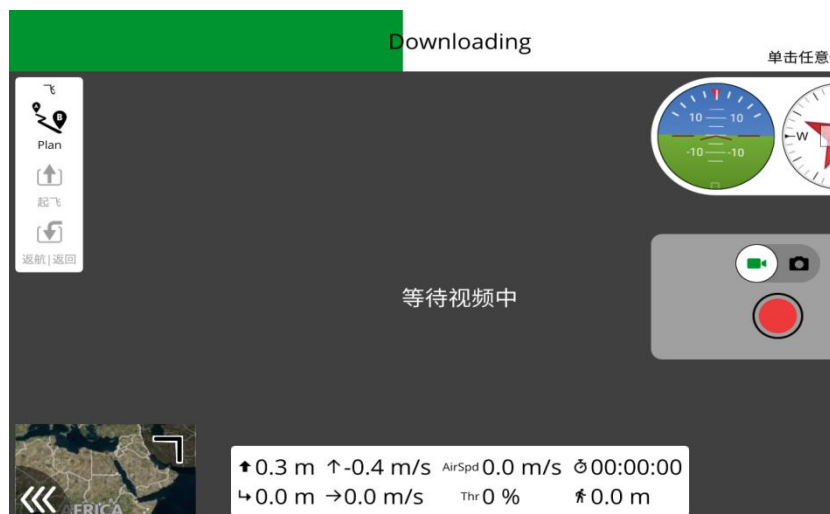



## Note:

When adding and setting up a connection for the first time in QGC, do not check the "Automatically Connect on Start" option. You may enable this option only after confirming that the telemetry connection can be successfully established.

### 4.4.2 Mission Planner

Open the “UniGCS” app, navigate to the telemetry settings, set the connection type to “Upgrade,” and set the baud rate to match the telemetry flight controller serial port.

1. Use the original Type-C upgrade cable to connect the Type-C port at the bottom of the ground unit to the PC. The PC will create a communication port for the ground unit.
2. Run the Mission Planner ground station software, select the corresponding port and baud rate, then click Connect.



3. Please patiently wait for the connection to establish.



## 4.5 Communication with Windows Ground Station via UDP through Ground Unit WiFi Hotspot

### 4.5.1 QGroundControl

1. Launch the UniGCS application, open the data transmission settings, set the connection type to UDP, and configure the baud rate to match the autopilot system data transmission serial port.
2. Enable the WiFi hotspot on the ground unit's Android system, and establish a WiFi connection between the ground unit and the Windows PC.
3. Run the QGC Ground Station software, navigate to the Application Settings menu, select Comm Links, and click Add to create a new connection.

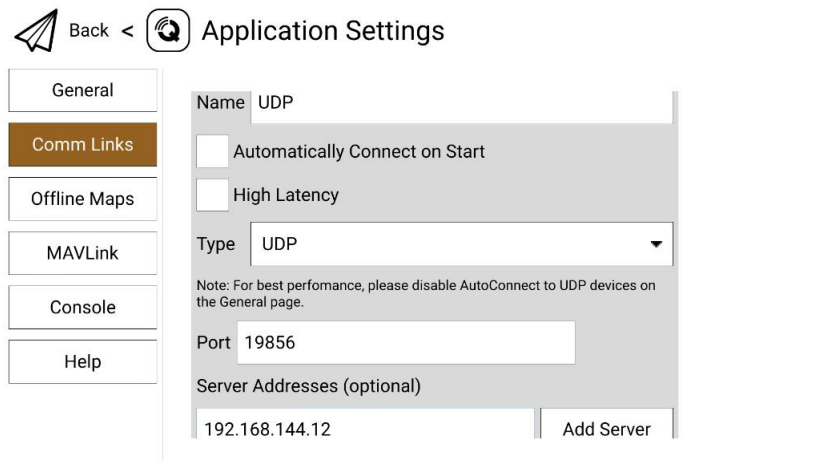

4. Name the connection “UDP”, set the connection Type to UDP, set the Port to 19856, enter the server address “192.168.144.20” in Server Addresses, then add the server by clicking Add Server, and finally click OK to return to the Comm Links menu.

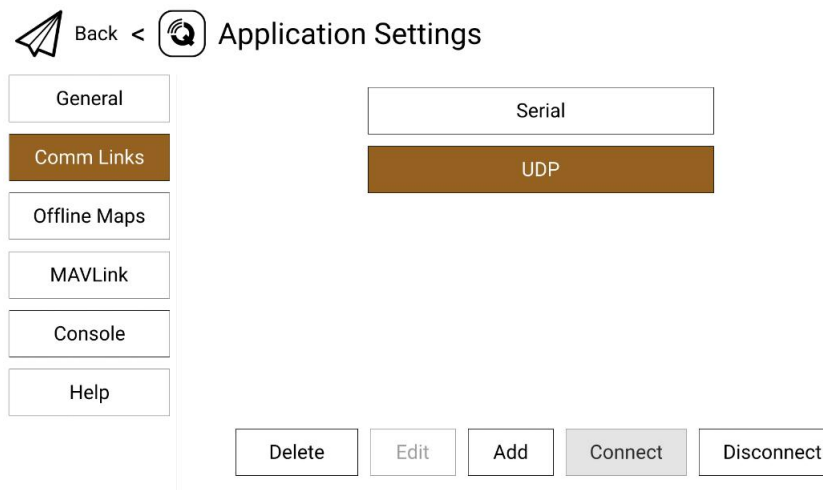

5. Select the configured “UDP” connection and click Connect. Once connected successfully, communication is established.

**Note:**

When adding and configuring a new connection type in QGroundControl (QGC) for the first time, please do not select the “Automatically Connect on Start” option. You can enable this option after confirming that the data transmission connection is successfully established.

# SIYI

## 4.5.2 Mission Planner

1. Open the “UniGCS” app, go to data transmission settings, set the connection type to “UDP,” and set the baud rate consistent with the autopilot’s data transmission serial port.
2. Enable the WiFi hotspot on the ground unit’s Android system, and connect the ground unit and Windows PC via WiFi.
3. Launch the Mission Planner ground station software, select the corresponding port (UDPCI) and baud rate, set the interface “Port” to “19856,” enter the server address “192.168.144.20,” then click “Connect.”



4. Patiently wait for the connection to establish.



## 4.6 Troubleshooting Data Transmission Connection Failures

When the ground unit and air unit are communicating normally, but the data transmission connection to the ground station software cannot be established successfully, please follow the steps below for troubleshooting:

1. First, ensure the air unit is properly connected to your autopilot system via the correct data transmission cable.
2. If using a DIY data transmission cable between the air unit and your autopilot, check the following:
  - Is the wiring sequence correct?
  - Are the TX and RX pins of the autopilot and air unit data transmission serial ports cross-connected properly?
  - Are Data Transmission Port 1 and Port 2 configured correctly?
3. In the "UniGCS" app, go to the "Link Information" menu and check the data values to verify communication between the autopilot and air

# SIYI

unit. Normal communication shows a "Data Transmission Downlink" value greater than 0. If the value is 0, return to steps 1 and 2 to check the cables.

4. In the "UniGCS" app, enter the "Data Transmission Settings" menu and verify:
  - Is the data transmission connection mode set correctly?
  - For PX4 / ArduPilot open-source autopilots or custom autopilots, is the baud rate set correctly?
  - In the autopilot ground station software, is the data transmission connection mode correctly configured?
5. For PX4 / ArduPilot or custom autopilots, try switching the data transmission cable connection to the TELEM 1 or TELEM 2 port.
6. Are both the ground unit and air unit running the latest firmware?
7. If using a wireless hotspot with UDP data transmission mode, disable the Ethernet connection on the PC and try connecting again.

## **Note:**

If you have already performed the above troubleshooting steps but the problem remains unresolved, please promptly contact your dealer or directly reach out to SIYI Technology for further diagnosis and support.

# SIYI

## Chapter 5 Image Transmission

The UniRC 7 Link supports up to 1080p resolution at 60 fps with low-latency real-time image transmission. It is compatible with SIYI Optical Pods and Gimbal Cameras, and also supports connection with third-party Ethernet cameras and optical pods. The UniRC 7 Air Unit is equipped with dual Ethernet ports, allowing simultaneous connection of two gimbals for image transmission. Additionally, an external Air Unit HDMI input module can be used to expand connectivity to cameras with HDMI input.



### Note:

When connecting two SIYI Optical Pods or Gimbal Cameras simultaneously to the UniRC 7 Air Unit, the IP address of one device must be changed to a value other than 192.168.144.25. During connection, the RTSP address must be manually entered to establish the link.

### 5.1 SIYI Gimbal Cameras (Optical Pods) AI Tracking via SIYI AI Tracking Module over SIYI Link

SIYI Optical Pods (Gimbal Cameras) can connect to the SIYI Link through the SIYI AI Tracking Module. Under normal Air Unit to Ground Station communication, AI recognition and tracking functions can be performed via the UniGCS application or the SIYI QGC application.

# SIYI

## Setup Steps:

1. Refer to the above diagram to connect the SIYI AI Tracking Module with the SIYI Gimbal Camera and the SIYI Link.
2. Confirm that the gimbal camera firmware has been updated to a version supporting the SIYI AI Tracking Module.
3. Launch the UniGCS application, go to "Address Settings," and select "SIYI AI Camera."

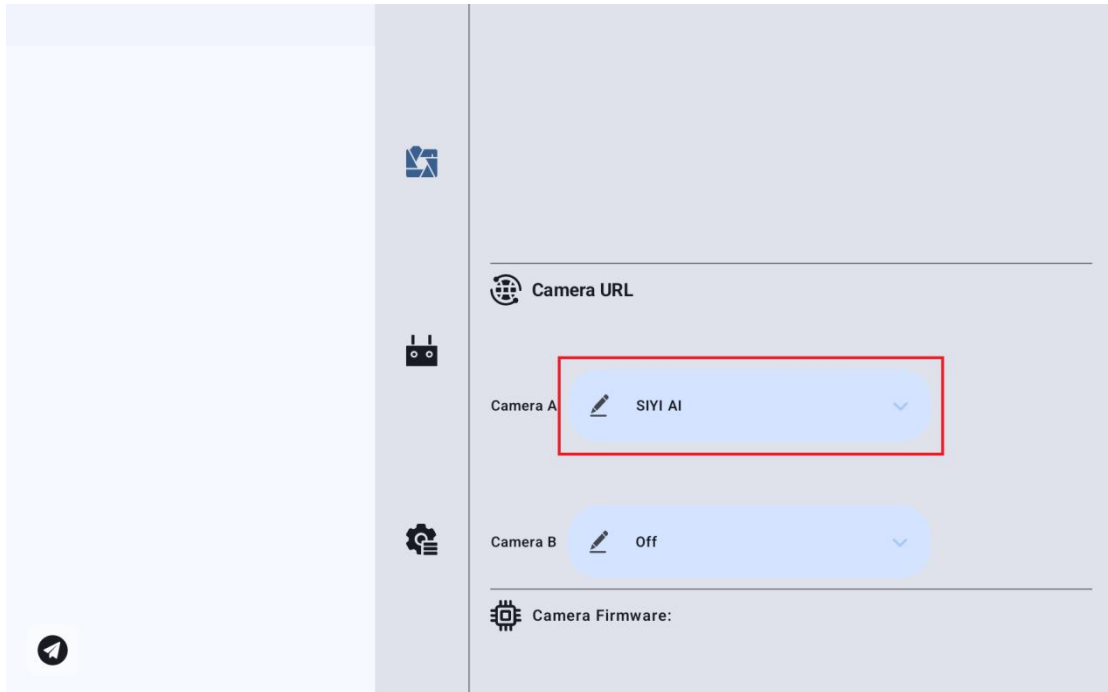

4. Return to the main screen and click the AI Tracking Recognition function button to activate the feature.



5. Click the AI Tracking Recognition function button again to deactivate the feature.

## 5.2 Control of SIYI Optical Pods (Gimbal Cameras) via SIYI Link Using UniGCS or SIYI QGC Android Applications

SIYI Optical Pods (Gimbal Cameras) can be directly connected to the SIYI Link. When communication between the Air Unit and Ground Control Station is established, the UniGCS or SIYI QGC Android applications can be used to control the gimbal's orientation and functions, as well as display the video feed.



## 5.2.1 Preparation

Before use, please prepare the following tools, firmware, and software:

- SIYI Link products (recommended to use UniRC7 Standard Kit, MK32 Standard Kit, HM30, or MK15 Industry Standard Kit together with SIYI Gimbal Cameras)
- SIYI Optical Pods (Gimbal Cameras)

### Note:

These products can be purchased from SIYI Technology or its authorized distributors.

- SIYI Gimbal Link Connection Cable

# SIYI

## **Note:**

These tools are included as standard accessories with the product shipment.

- UniGCS Application
- SIYI QGC Application

## **Note:**

These software applications can be downloaded from the official SIYI website product pages.

### **UniGCS Application Usage Steps:**

1. Power on the Air Unit and ensure communication between Air Unit and Ground Control Station (GCS).
2. Use the SIYI Gimbal Link Connection Cable to connect the Air Unit's network port to the gimbal's network port.
3. Update the UniGCS application on the ground station to the latest version.
4. Run the UniGCS app, enter the Settings menu, and under Address Settings select the corresponding SIYI camera type and main/sub-stream to display the camera feed and control the gimbal's orientation and functions via the app.

# SIYI

## SIYI QGC Application Usage Steps

1. Power on the Air Unit and ensure communication between Air Unit and GCS.
2. Use the SIYI Gimbal Link Connection Cable to connect the Air Unit's network port to the gimbal's network port.
3. Run the SIYI QGC app, go to “general” settings, under “Video Settings” select “RTSP Video Stream” as the Source, then input the default RTSP address of the SIYI Pod/Gimbal camera to display the live video and control gimbal orientation and functions through the app.

### 5.2.2 Gimbal pitch and yaw

When running UniGCS or SIYI QGC apps,

long press on the ground station touchscreen and slide left or right to control the yaw-axis. long press and slide up or down to control the pitch-axis. The gimbal moves in the same direction as the finger swipe.

Double-tap the screen to auto-center the gimbal.



#### **Note:**

After sliding, keep pressing the touchscreen to keep the gimbal moving until reaching the maximum angle. The farther the press position is from the screen center, the faster the gimbal rotates.

# SIYI

## 5.2.3 Zoom Control

When running UniGCS or SIYI QGC apps, tap the “Zoom In” or “Zoom Out” icons on the touchscreen to control the zoom level.

## 5.2.4 Photo and Video Recording

When running UniGCS or SIYI QGC apps, tap the “Photo” icon on the touchscreen to take a photo. Tap the “Record” icon to start video recording, and tap the “Recording” icon again to stop recording.



### **Note:**

Before using photo or video functions, an SD/TF card must be inserted into the gimbal camera.

# SIYI

## 5.3 SIYI Link Control of SIYI Pods (Gimbal Cameras) via SIYI QGC (Windows) Software

The gimbal can be directly connected to the Air Unit, and when communication between the Air Unit and Ground Station is established, the SIYI QGC (Windows) application can be used to control gimbal orientation and functions as well as display the video feed.



### 5.3.1 Preparation

Before use, ensure the following tools, firmware, and software are properly prepared:

- SIYI Link Products (It is recommended to use the UniRC 7 Standard Kit, MK32 Standard Kit, HM30, or MK15 Enterprise Standard Kit in

# SIYI

combination with SIYI gimbal cameras.)

- SIYI Optical Pods (Gimbal Cameras)

## **Note:**

The above products can be purchased from SIYI Technology or its authorized distributors.

- SIYI Gimbal Link Cable

## **Note:**

This cable is included as a standard accessory in the product package.

- SIYI QGC (Windows) Software

## **Note:**

The software can be downloaded from the product page on the official SIYI website.

### **Steps to Use SIYI QGC (Windows)**

1. Power on the Air Unit and ensure communication between the air unit and the ground unit is established.
2. Connect the Air Unit's Ethernet port to the gimbal quick-release

# SIYI

dampening board's Ethernet port using the SIYI Gimbal Link Cable.

3. Connect the SIYI Link Ground Unit to your Windows computer.
4. Adjust your computer's Ethernet settings to match the SIYI Link configuration and avoid IP conflicts.

For example: IP address: 192.168.144.30

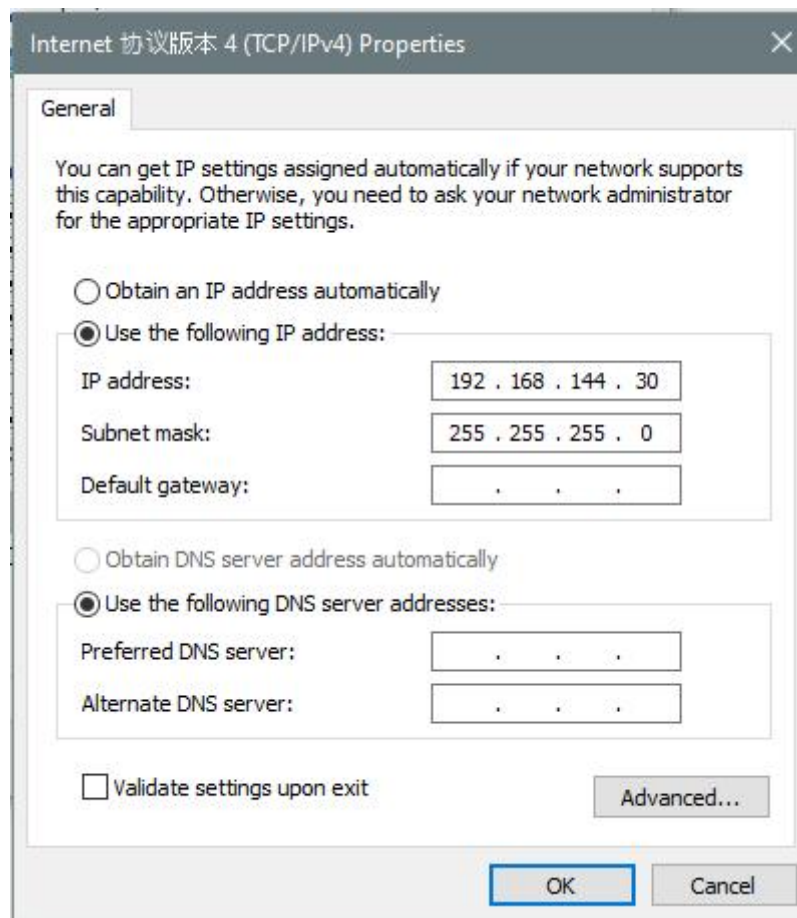

5. Launch the SIYI QGC software, navigate to the "Communication Connection" settings, go to the "Video Settings" menu, set "Source" to "RTSP Video Stream", and enter the default RTSP address of the SIYI optical pod / gimbal camera. Once configured, the video feed will be displayed, and the gimbal's orientation and functions can be

# SIYI

controlled via mouse through the ground control station.

## 5.3.2 Gimbal Pitch and Yaw control

When running SIYI QGC, press and hold on the video screen of the ground station, then drag the mouse cursor left or right to control the gimbal's horizontal Yaw; drag up or down to control the gimbal's vertical Pitch. The gimbal moves in the same direction as the mouse cursor drag. Double-clicking the screen will reset the gimbal to center.



### Note:

While holding the mouse button, the gimbal will continue to move until reaching its maximum angle. The farther the cursor is from the screen center, the faster the gimbal rotates.

## 5.3.3 Zoom and Focus

When running SIYI QGC, use the mouse to click the "Zoom In" or "Zoom Out" icons on the interface to control zoom.

Click on the screen, and the optical zoom camera will automatically focus.

# SIYI

## 5.3.4 Photo and Video Capture

When running SIYI QGC, click the "Capture Photo" icon on the interface to take a photo.

Click the "Start Recording" icon to begin recording; click the "Recording" icon again to stop.



### **Note:**

Make sure to insert an SD / TF card into the gimbal camera before using photo or video functions.

## 5.4 Connecting SIYI Link to Third-Party IP Cameras

Before connecting a third-party IP camera or gimbal, set its IP address to the 192.168.144.X range.

Do not use: 192.168.144.11, 192.168.144.12, or 192.168.144.20 as these are reserved for the air unit, ground unit, and Android system, respectively. Otherwise, the system will not function properly.

### **Steps:**

1. Access your IP camera or gimbal's configuration page and copy the RTSP address.

# SIYI

2. Using QGroundControl as an example, open the QGC Ground Station Software, navigate to the General settings menu, and scroll down to Video Settings.

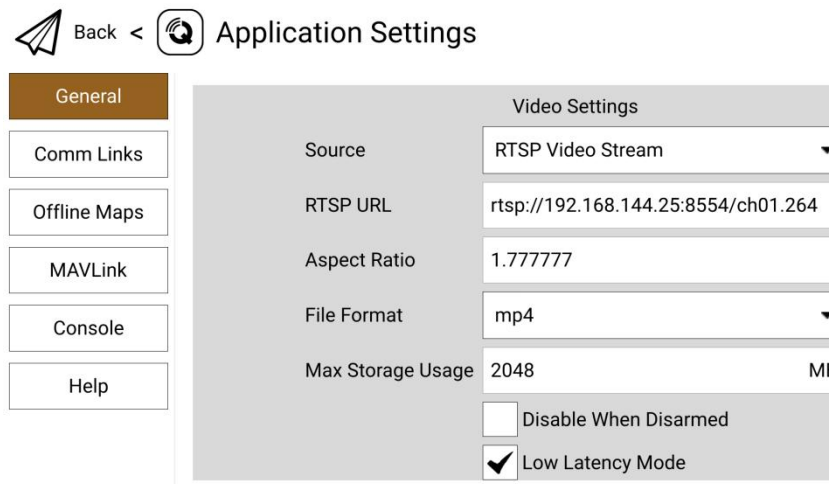

3. Set the video source to “RTSP Video Stream,” then paste the previously copied RTSP address of the IP camera or gimbal into the “RTSP URL” field below.

4. Return to the ground station main interface to view the video feed.

## 5.5 Integrating SIYI Link with HDMI Cameras

Cameras that only support HDMI output must be connected to the SIYI Air Unit via the SIYI HDMI Input Module. Please follow the steps below:

1. Using QGroundControl as an example, open the QGC ground station software, navigate to the General settings menu, and scroll down to Video Settings.

# SIYI

2. Set the video source to “RTSP Video Stream,” then enter the RTSP address of the SIYI HDMI video conversion module in the “RTSP URL” field.

3. Return to the ground station main interface to view the video feed.

## **5.6 Integrating SIYI Link with Dual Video Streams**

When integrating dual video streams via SIYI Link, two cameras can be connected simultaneously to the LAN1 and LAN2 ports of the UniRC 7 Air Unit. SIYI Link supports multiple dual video stream connection methods.

### **5.6.1 Connecting Two SIYI Cameras or Two HDMI Input Modules**

Assign different IP addresses to the two SIYI cameras or HDMI input modules, such as “192.168.144.25” and “192.168.144.26”. After connecting both cameras to the UniRC 7 Air Unit and launching the UniGCS application, select “Camera A” and “Camera B” in the IP address fields to view dual video streams.

### **5.6.2 Connecting Two Third-Party IP Cameras or Optical Pods**

Ensure that the two cameras/pods have different IP addresses and are connected to UniRC 7. Open the SIYI UniGCS application and enter the corresponding RTSP addresses in the IP address fields to display dual

# SIYI

video streams.



## Note

Dual video stream functionality will not work if the IP addresses of the two streams are the same.

For detailed information on SIYI Link remote control and gimbal component IP addresses, please refer to section 5.8 of this manual.

## 5.7 Common Device Parameters

SIYI Link Air Unit IP Address: 192.168.144.11

SIYI Link Ground Unit IP Address: 192.168.144.12

SIYI Handheld Ground Station Android System IP Address:  
192.168.144.20

SIYI AI Tracking Module Default IP: 192.168.144.60

SIYI Optical Pod (Gimbal Camera) Default IP: 192.168.144.25

(New) Default RTSP Addresses for SIYI Cameras/Gimbals:

SIYI AI Camera: rtsp://192.168.144.60/video0

- Main Stream: rtsp://192.168.144.25:8554/video1
- Sub Stream: rtsp://192.168.144.25:8554/video2
- (New) UniGCS App Custom Protocol Addresses:

# SIYI

- Camera A: 192.168.144.25:37256
- Camera B: 192.168.144.25:37255

SIYI Rugged Camera A IP: 192.168.144.25

SIYI Rugged Camera B IP: 192.168.144.26

SIYI HDMI Input Module IP: 192.168.144.25

SIYI Rugged Camera A RTSP Address:

rtsp://192.168.144.25:8554/main.264

SIYI Rugged Camera B RTSP Address:

rtsp://192.168.144.26:8554/main.264

SIYI HDMI Input Module RTSP Address:

rtsp://192.168.144.25:8554/main.264

Common Video Playback Software: UniGCS, SIYI FPV, SIYI QGroundControl, EasyPlayer

Network Diagnostic Tool: Ping Tools

## Note

Camera products released after the ZT30 use the new address format, including ZT30, ZT6, etc.

Products released before ZT30 still use the old address format, including ZR30, A2 mini, A8 mini, ZR10, and R1M SD-recording FPV cameras.

# SIYI

RTSP addresses are labeled on all SIYI IP cameras and HDMI input modules before shipment. Please refer to them accordingly.

## 5.8 Troubleshooting Video Feed Display Issues

If video cannot be displayed via the SIYI Link, please follow these steps to troubleshoot:

1. Check the connections:

- Ensure the Ground Unit and Air Unit are paired (i.e., status indicators on both units are green).
- Ensure proper wiring between the camera and the Air Unit (use Ping Tools to test the link between camera and system).

2. Check software settings:

- In UniGCS: confirm the camera address field is set correctly.
- In QGroundControl: confirm the video settings are configured properly.

If video cannot be displayed on the SIYI handheld ground station, please check the Android system's network status:

Ethernet Switch: Make sure the Ethernet icon is visible on the Android main interface. If not, go to the Android settings to enable the Ethernet function.

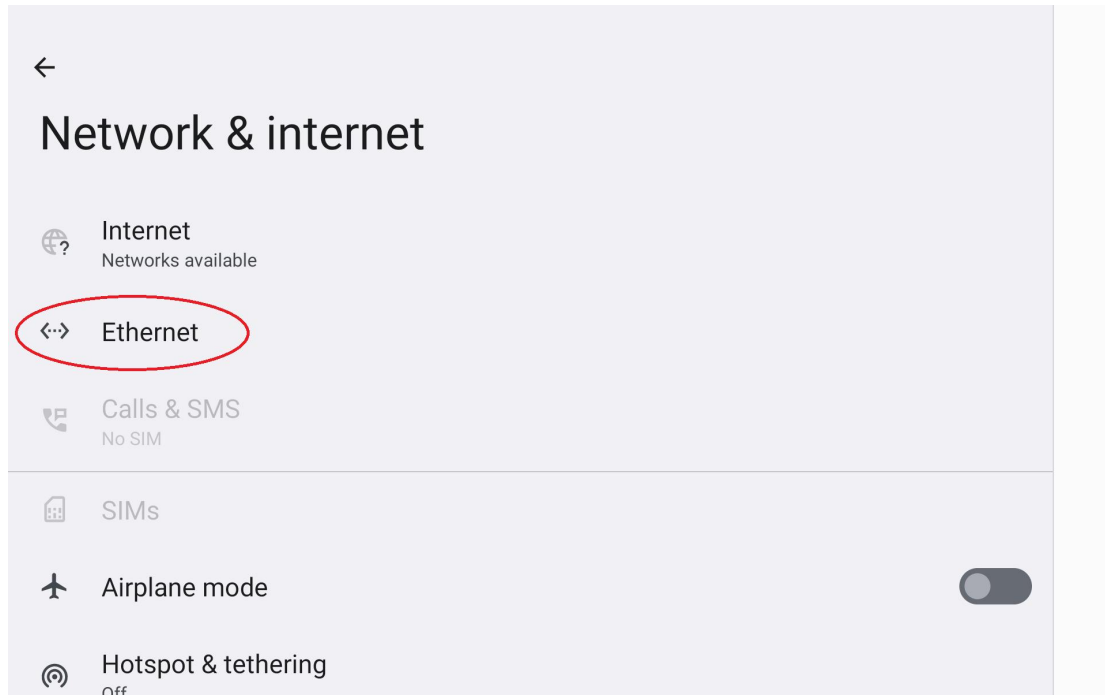

## Note

If you are still unable to identify the issue after following the above troubleshooting steps, please contact your dealer or SIYI Technology directly for further assistance.

## **5.9 Outputting Video from the Ground Unit to Other Devices**

UniRC 7 ground unit supports multiple methods for outputting video to external display devices.

### **5.9.1 Output via the Ground Unit's HDMI Port**

To output video to an HDMI monitor:

Use a standard HDMI cable to connect the UniRC 7 Pro ground unit's HDMI port to the monitor's HDMI input. The monitor will then display a

# SIYI

real-time screen mirror of the ground unit.

## 5.9.2 Output via Ground Unit Wi-Fi Hotspot Sharing

To share video to a Windows laptop using QGC as an example:

1. Open the Android system settings.
2. Navigate to: Network & Internet → Hotspot & Tethering → Wi-Fi Hotspot.

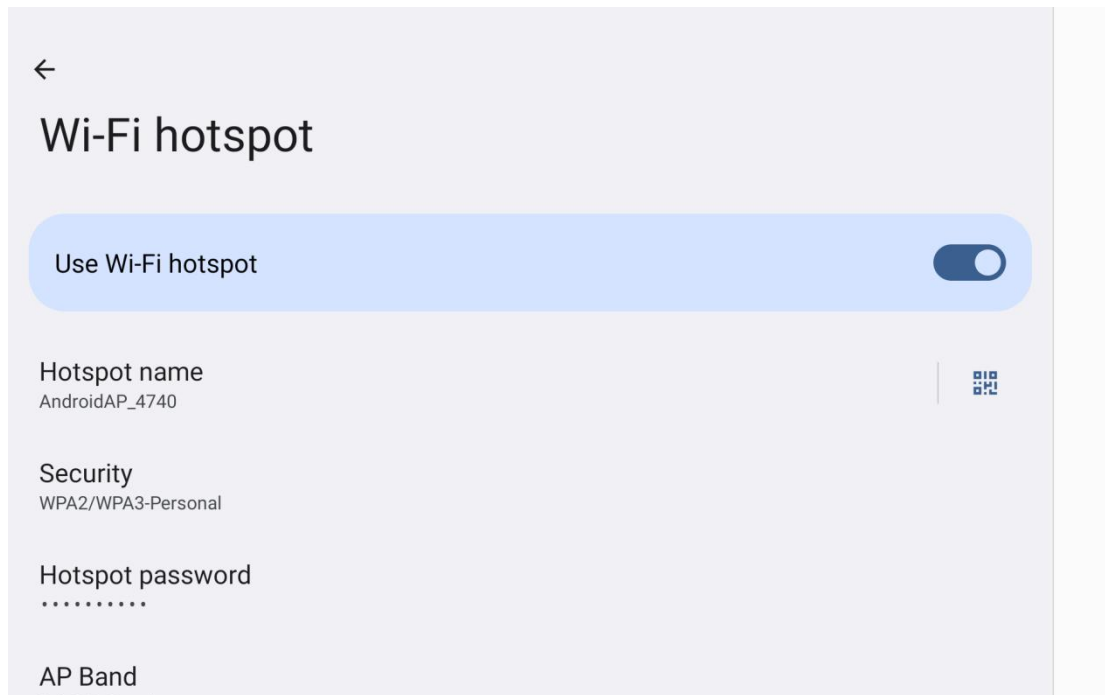

3. Enable the hotspot and configure the hotspot name and password.
4. Connect the Windows laptop to the hotspot shared by the UniGCS ground unit.
5. On the laptop, launch the QGC ground station software. Navigate to Application Settings → Video, and set the video source to RTSP Video Stream.

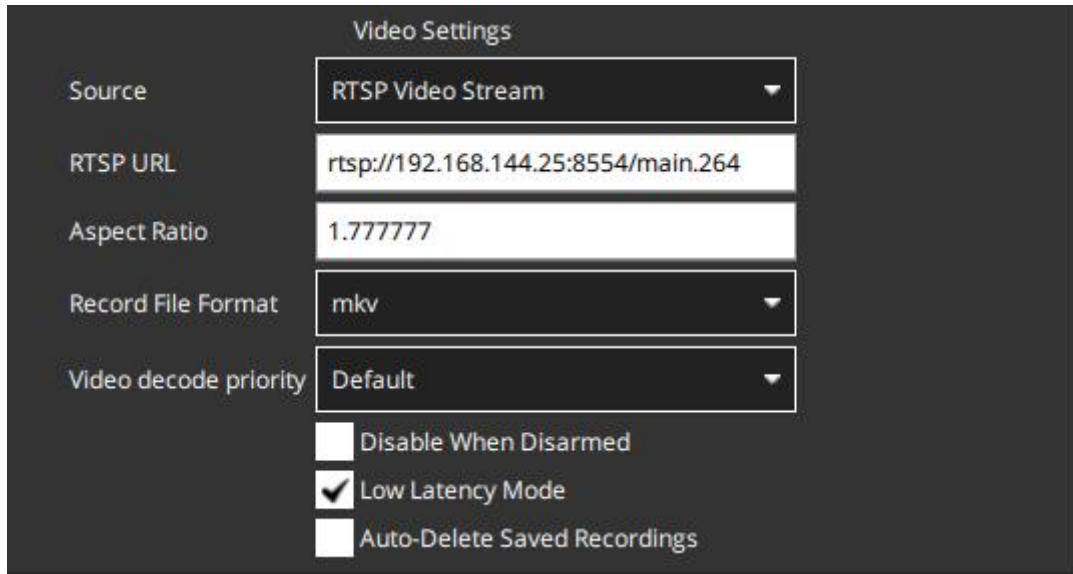

6. In the RTSP URL field, enter the RTSP address of the camera device connected to the air unit. The corresponding video feed will then be displayed.

## Note

If the external device sharing video via the ground unit's WiFi hotspot and the software running on the UniRC 7 ground station are displaying the same video stream simultaneously, image stuttering may occur due to bandwidth limitations. In this case, please disable one of the video streams, or set one stream source to “SIYI Camera 1/2” and keep the other using the RTSP address.

### 5.9.3 Outputting Video via Ethernet Port

1. Ensure that the UniRC 7 PRO link is in communication and that the air unit's video input interface is connected to a camera or gimbal pod.
2. Use an RJ45-to-4-pin adapter cable to connect the LAN port on the

top of the UniRC 7 PRO ground unit to a PC.

3. On the PC, open Ethernet settings. Click “Change adapter options” and locate the newly added network connection.

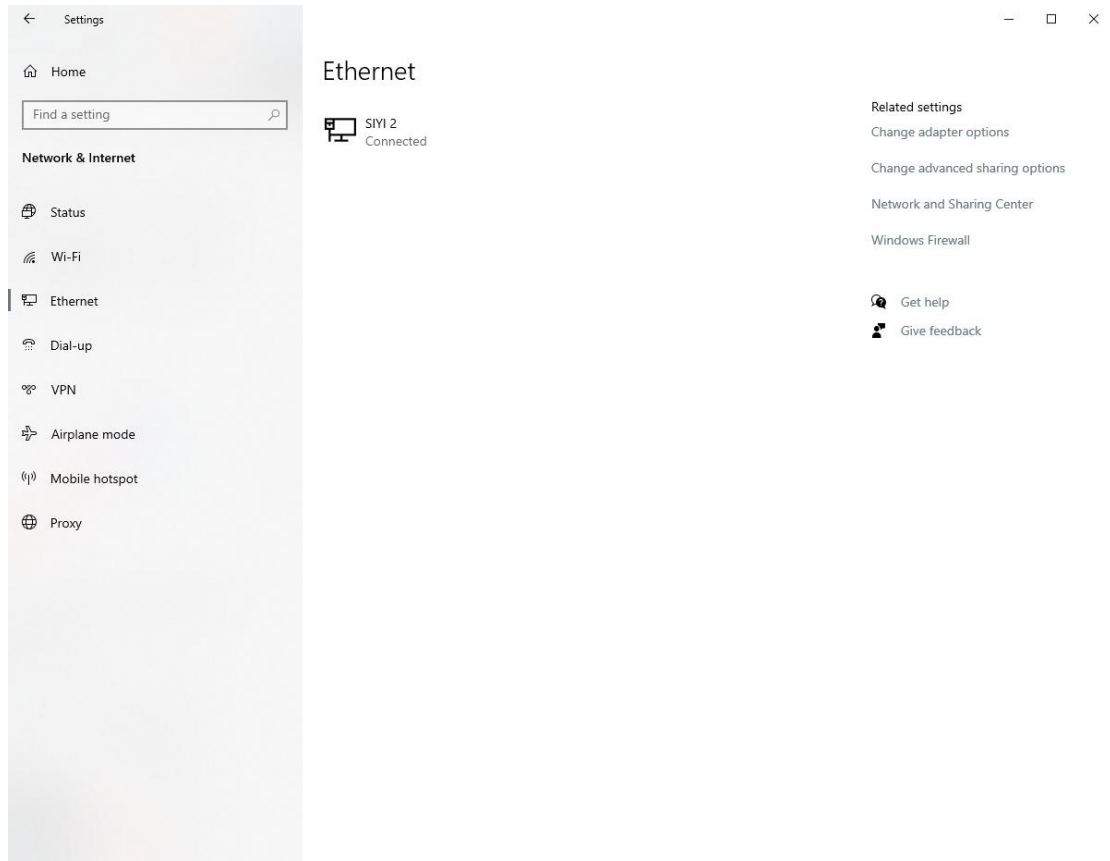

4. Locate the newly added network connection, then click “Properties” → “Internet Protocol Version 4 (TCP/IPv4),” and set the IP address as follows:

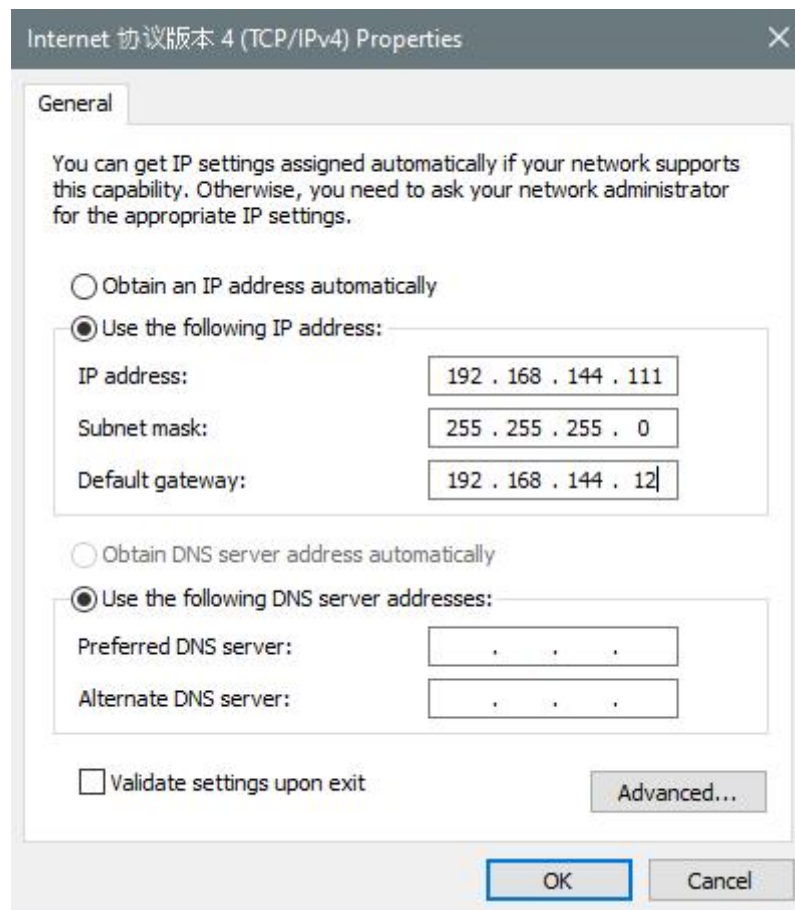
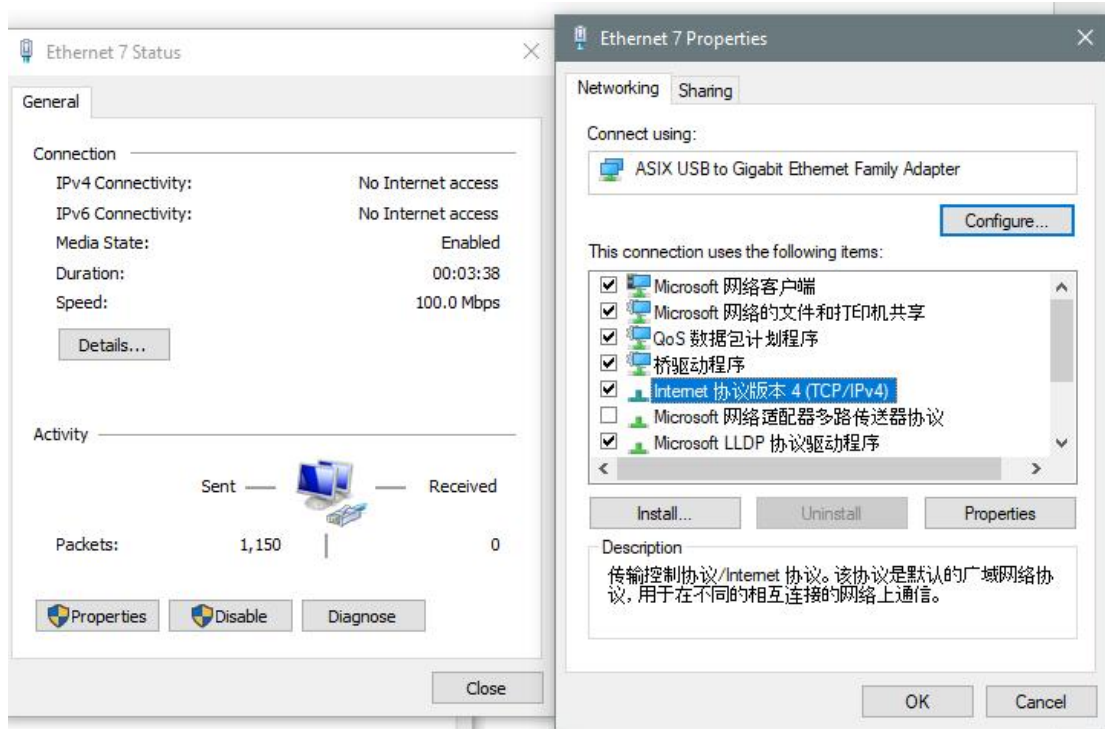

5. Run the RTSP streaming software EasyPlayer.

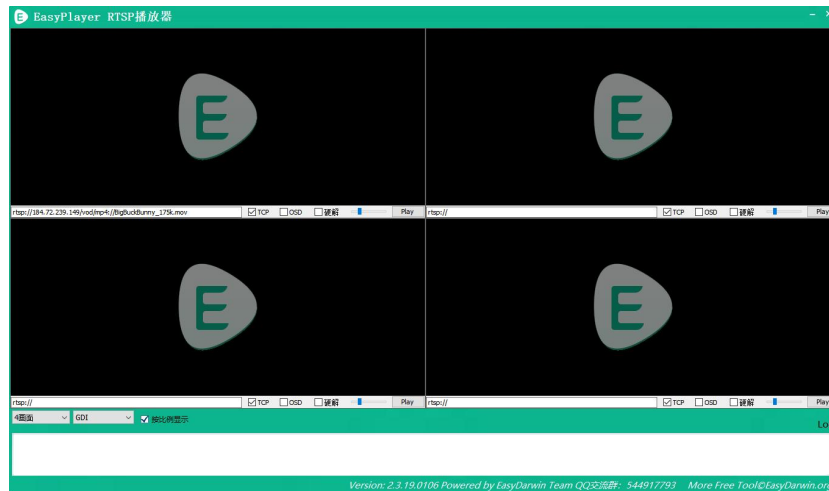

6. Enter the full RTSP address of the camera or gimbal pod in the EasyPlayer IP address field to display the video feed.

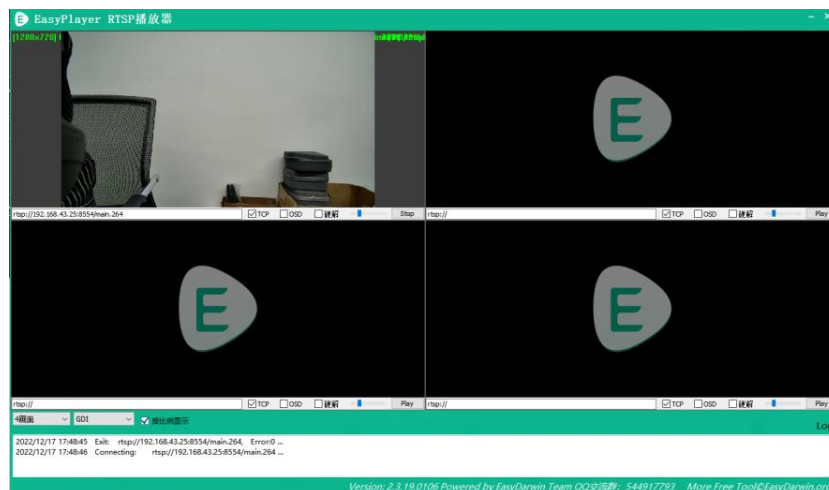

7. If the video feed cannot be displayed properly, first open the Ping application on the UniRC 7 ground station to check network connectivity, then on the PC press the “Win+R” keys to open the menu shown below.

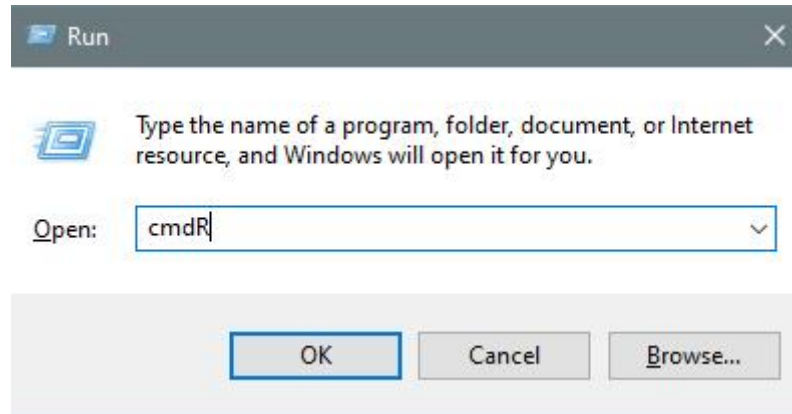

8. Type “cmd” and press Enter to open the Ping program. Refer to the image below to input the camera’s IP address. If there is a response, it indicates that the network communication is normal and the video feed should work properly; if there is no response, it means the link is disconnected and you need to check the wiring or connection status.

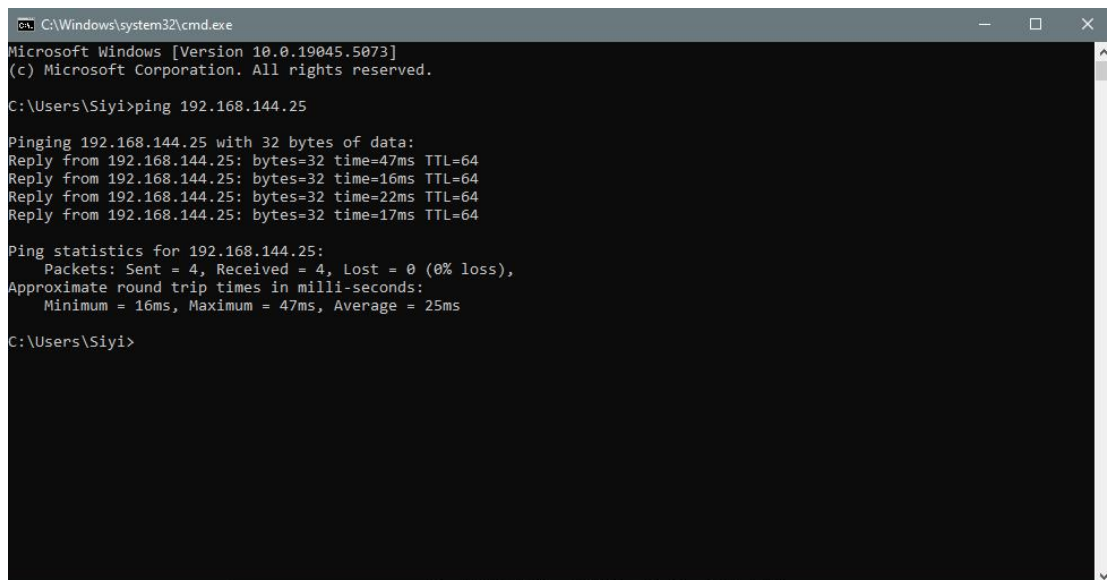

## Chapter 6 SDK Communication Protocol

### 6.1 Protocol Format Description

Field	Index	Byte Size	Description
STX	0	2	Start Flag, fixed value: 0x5566
CTRL	2	1	Control Byte: <ul style="list-style-type: none"> <li>• Bit 0: need_ack — whether an ACK is required</li> <li>• Bit 1: ack_pack — whether this is an ACK packet</li> <li>• Bits 2–7: Reserved</li> </ul>
Data_len	3	2	Length of the Data field (little-endian)
SEQ	5	2	Frame sequence number (0–65535), little-endian
CMD_ID	7	1	IDCommand ID
DATA	8	Data_len	date
CRC16		2	CRC-16 checksum for the entire packet, little-endian

### 6.2 Communication Commands

#### 6.2.1 0x40: Get Remote Controller Hardware ID

CMD_ID:0x40----- Hardware ID			
Send Data Format			
No.	Data Type	Data Name	Description

ACK Data Format			
	UInt8_t	hardware_id[12]	Hardware ID String (10-digit)

eg:

Send (HEX) : 55 66 01 00 00 00 00 40 81 9c

Receive (HEX) : 55 66 02 0C 00 09 00 40 36 38 30 31 31 33 30 31 31 31 00 00 7b 8b

## 6.2.2 0x16: Get System Settings

CMD_ID:0x16-----Get System Settings			
Send Data Format			
No.	Data Type	Data Name	Description
ACK Data Format			
	UInt8_t	match	Pairing Command Values (0: Start Pairing; 1, 2: Pairing in Progress; 3: Pairing Complete)
	UInt8_t	Com1_baud_type	Air Unit UART1 Baud Rate 1: BAUD_9600 3: BAUD_57600 5: BAUD_115200
	UInt8_t	Joy_type	Joystick type value (0-3 corresponds to Mode 1 - Mode 2 - Mode 3 - Custom)
	UInt8_t	Rc_bat	Remote controller battery voltage ×10
	UInt8_t	Com2_baud_type	Air Unit UART2 baud rate 1: BAUD_9600 3: BAUD_57600 5: BAUD_115200

## 6.2.3 0x17: System Settings

CMD_ID:0x17-----System Settings			
Send Data Format			
No.	Data Type	Data Name	Description
	Uint8_t	match	Binding Command Value (1: Enable Binding; 0: Disable Binding) When this field is set, its value is 1; When this field is not set, its value is 0.
	Uint8_t	Com1_Baud_type	Air Unit UART1 Baud Rate 1: BAUD_9600 3: BAUD_57600 5: BAUD_115200
	Uint8_t	Joy_type	Joystick Type Value (0-3): 0: Japanese Mode 1: American Mode 2: Chinese Mode 3: Custom Mode
	Uint8_t	reserved	
	Uint8_t	Com2_Baud_type	Air Unit UART2 Baud Rate 1: BAUD_9600 3: BAUD_57600 5: BAUD_115200
ACK Data Format			
	int8_t	sta	1 ok A negative value indicates a configuration error.



## 6.2.5 0x43: Retrieve Remote Link Information

CMD_ID:0x43----- Retrieve Remote Link Information			
Send Data Format			
No.	Data Type	Data Name	Description
ACK Data Format			
	uint16_t	freq	Frequency
	uint8_t	pack_loss_rate	Packet Loss Rate
	uint16_t	real_pack	Valid Packets
	uint16_t	real_pack_rate	Valid Packet Rate
	uint32_t	data_up	Uplink Data Rate (bytes/s)
	uint32_t	data_down	Downlink Data Rate (bytes/s)
	uint32_t	data_up_2	Uplink Data Rate for Link 2 (bytes/s)
	Uint32_t	Data_down_2	Downlink Data Rate for Link 2 (bytes/s)

eg:

Send (HEX) : 55 66 01 00 00 00 00 43 e2 ac

Response (HEX) :

## 6.2.6 0x44: Retrieve Video Link Information

CMD_ID:0x44-----Retrieve Video Link Information			
Send Data Format			
No.	Data Type	Data Name	Description
ACK Data Format			
	uint16_t	video_up	Video Uplink Bitrate (video_up / 10) Kbps
	uint16_t	video_down	Video Downlink Bitrate (video_down / 10) Mbps
	uint8_t	channel	Video Transmission Channel (1-16)
	int16_t	signal_strength	0-100% (5 levels: 0, 20, 40, 60, 80, 100)
	uint8_t	signal_quality	-15 to 30 (no unit). The higher the value, the better the signal quality. Tiers: - Strong: 10 and above - Medium: 5-10 - Weak: below 5

eg:

Send (HEX) : 55 66 01 00 00 00 00 44 05 dc

Response (HEX) :

## 6.2.7 0x47: Retrieve Firmware Version Number

CMD_ID:0x47-----Retrieve Version Number			
Send Data Format			
No.	Data Type	Data Name	Description
ACK Data Format			
	uint32_t	rc_version	Remote Controller Firmware Version
	uint32_t	rf_version	Receiver Firmware Version
	uint32_t	ground_version	Ground Unit Video Transmission Firmware Version
	uint32_t	sky_version	Air Unit Video Transmission Firmware Version

ps: he retrieved version number is a 4-byte hexadecimal value, where the lowest byte is the first byte, and the highest byte is the last byte. Ignore the first byte; the remaining three bytes represent the version number in the format: major.minor.patch.

eg:

Send (HEX) : 55 66 01 00 00 00 00 47 66 ec

Reply (HEX) : 55 66 02 10 00 02 00 47 00 03 05 68 07 02 05 69 02 02 00 56 02 02 00 56 6d 21

## 6.2.8 0x48: Retrieve All Channel Mappings

CMD_ID:0x48-----Retrieve All Channel Mappings			
Send Data Format			
No.	Data Type	Data Name	Description
ACK Data Format			
1	UInt8_t	Ch1_type	Mapped Physical Channel Type: 0 – Joystick, dial, or similar channels 1 – Button or similar channels
1	uint8_t	Ch1_entity_id	Physical Channel ID
2	UInt8_t	Ch2_type	Mapped Physical Channel Type: 0 — Joystick, dial, or similar channels 1 — Button or similar channels
2	uint8_t	Ch2_entity_id	Physical Channel ID
3	UInt8_t	Ch3_type	Mapped Physical Channel Type: 0 – Joystick, dial, and similar channels 1 – Button and similar channels
3	uint8_t	Ch3_entity_id	Physical Channel ID
4	UInt8_t	Ch4_type	Mapped Physical Channel Type: 0 — Joystick, dial, and similar channels 1 — Button and similar channels
4	uint8_t	Ch4_entity_id	Physical Channel ID
.....	uint8_t	.....	

eg:

Send (HEX) : 55 66 01 00 00 00 00 48 89 1d

Reply (HEX) : 55 66 02 20 00 16 00 48 00 00 00 01 00 02 00 03 05 00 05 01 05 02 01 00 01 01 01 02 01 03 00 04 00 05 02 01 02 00 03 00 C1 28

## 6.2.9 0x49: Retrieve Channel Mapping

CMD_ID:0x49-----Retrieve Channel Mapping			
Send Data Format			
No.	Data Type	Data Name	Description
	UInt8_t	rc_ch	RC Channels (1-16)
ACK Data Format			
	UInt8_t	rc_ch	RC Channels (1-16)
	uint8	Type	Mapped Physical Channel Type: 0 — Joystick, dial, and similar channels 1 — Button and similar channels
	uint8_t	entity_id	Physical Channel ID

eg:

Send (HEX) : 55 66 01 01 00 00 00 49 02 4F 1C

Reply (HEX) : 55 66 02 03 00 17 00 49 02 00 01 33 9F

Channel Mapping Type Definition

Category	Type	entity_id	Physical Switch Definition
Joystick	0	0	J1
	0	1	J2
	0	2	J3
	0	3	J4
	0	8	J5
	0	9	J6
Dial	0	4	LD1
	0	5	RD1
3-Position Switch	5	0	SA
	5	1	SB
Button	1	0	S1
	1	1	S2
	1	2	S3
	1	3	S4
	1	4	L1
	1	5	L2
	1	6	R1

# SIYI

	1	7	R2
	1	8	R3
	1	9	M1
	1	10	M2
	1	11	M3
	1	12	M4
	1	13	M5
	1	14	M6
Virtual Channel	2	0	NULL
	2	1	RSSI
No Physical Channel Mapped	3	0	NULL

## 6.2.10 0x4A: Set Channel Mapping

CMD_ID:0x4A-----Set Channel Mapping			
Send Data Format			
No.	Data Type	Data Name	Description
	UInt8_t	rc_ch	RC Channel (1–16)
	uint8	Type	Mapped Physical Channel Type: 0 — Joystick, dial, and similar channels 1 — Button and similar channels
	uint8_t	entity_id	Physical Channel ID
ACK Data Format			
	UInt8_t	rc_ch	RC Channel (1–16)
	int8_t	sta	1 ok Negative values represent error codes.

eg:

Send (HEX) : 55 66 01 03 00 00 00 4A 02 00 00 4F EB

Reply (HEX) : 55 66 02 02 00 18 00 4A 02 01 4C C3



# SIYI

eg:

Send (HEX) : 55 66 01 01 00 00 00 4C 02 BA E3

Reply (HEX) : 55 66 02 02 00 1C 00 4C 02 FF 3B F6

## 6.2.13 0x4D: Set Channel Reversal

CMD_ID:0x4D-----Set Channel Reversal			
Send Data Format			
No.	Data Type	Data Name	Description
	UInt8_t	rc_ch	RC Channel (1-16)
	int8_t	reverse	Reversal (1: Normal, -1: Reversed)

eg:

Send (HEX) : 55 66 01 02 00 00 00 4D 02 FF 0F 86

Reply (HEX) : 55 66 02 02 00 1D 00 4D 02 01 8B 65

## 6.2.14 0x4E: Get multi-device interconnection status

CMD_ID: 0x4E — Get the remote controller's multi-device interconnection status			
Send Data Format			
No.	Data Type	Data Name	Description
ACK Data Forma			
0	UInt8_t	rc_multi_ctl_mode	Multi-device interconnection mode of the device: 0: Dual control master 1: Dual control slave 2: Remote control relay master 3: Remote control relay slave 4: Relay 5: Single control

# SIYI

1	UInt8_t	main_vice_link_status	<p>Link connection status of the other device (when this unit is the master, it obtains the connection status of the slave; vice versa):</p> <p>0: Not connected.            1: Connected.            2: This unit is out of control and cannot obtain the connection status of the other device.</p>
2	UInt8_t	rc_relay_status	<p>Remote control relay channel control status:</p> <p>0: Master has channel control authority.            1: Slave has channel control authority.            2: This unit is out of control and cannot obtain the control status of the other device.</p>
3	UInt8_t	dual_ctl_status	<p>Dual control enable switch:</p> <p>0: Disabled — master controls all channels.            1: Enabled — slave is allowed to control the assigned slave channels.</p>

eg:

Send (HEX) : 55 66 01 00 00 00 00 4e 4f 7d

Reply (HEX) : 55 66 02 04 00 02 00 4E 03 01 00 00 40 AB

## 6.2.15 0x4F: Get system status (actively sent when there is a warning)

CMD_ID:0x4F — Get system status			
Send Data Format			
No.	Data Type	Data Name	Description
	UInt8_t	freq	<p>Output frequency:</p> <p>0: Disable sending            1: Enable sending</p>

ACK Data Forma			
1	uint8_t	G_led_status	Remote controller system light status: 0: No status 1: Ground unit and air unit not communicating (reserved) 2: Binding in progress (reserved) 3: MCU firmware mismatch 4: Link initialization failed 5: Ground unit joystick requires calibration 6: Video transmission starting / video transmission firmware upgrading (reserved) 7: Upgrading air unit firmware (reserved) 8: Ground unit power supply voltage abnormal 9: Ground unit Bluetooth not recognized 10: Ground unit temperature level 1 alarm 11: Ground unit temperature level 2 alarm 12: Ground unit temperature level 3 alarm 13: Video transmission firmware mismatch 14: Data link valid packet rate 100% (reserved) 15: Data link valid packet rate 99%–95% (reserved) 16: Data link valid packet rate 75%–50% (reserved) 17: Data link valid packet rate 50%–25% (reserved) 18: Data link valid packet rate below 25% (reserved)
2	Uint8_t	s_led_status	Air unit system light status: 0: No status 1: Voltage alarm (input voltage below 12V) 2: Air unit temperature level 1 alarm 3: Air unit temperature level 2 alarm 4: Air unit temperature level 3 alarm

eg:

Enable active sending (HEX): 55 66 01 01 00 00 00 4f 01 8a 86

Enable active sending response (HEX): 55 66 02 01 00 00 2B 00 4F 01 59 77

Disable active sending (HEX): 55 66 01 01 00 00 00 4f 00 ab 96

Disable active sending response (HEX): 55 66 02 01 00 AF 00 4F 01 90 60

Active system status send (HEX): 55 66 02 02 00 E7 00 4F 03 00 03 51

# SIYI

## 6.3 Communication Interfaces

### 1. Serial Port

Port name: /dev/ttyHS3

Baud rate: 115200

### 2. Bluetooth

### 3. Type-C (USB virtual serial port, external interface)

### 4. UDP Interface (Server IP: 192.168.144.20, Port number: 19856)

Avoid using port 19856 on the client side, or it will conflict with the server.

#### Note:

When using the serial interface, the ground station app identifies and matches different controllers based on the Android system model name (ro.product.model):

Standard Version: Standard\_94

Pro Version: Pro\_94

Two data transmission interfaces and one SDK interface can be selected.

Available combinations are shown above.

(Use the UniGCS App to switch data transmission and SDK interfaces.)

	Data Transmission Interface 1	Data Transmission Interface 2	SDK Interface
Combo 1	Serial/Bluetooth	Bluetooth/Serial	Serial/Bluetooth/Type-C

Combo 2	Serial/Type-C	Type-C/Serial	Serial/Bluetooth/Type-C
Combo 3	UDP/Bluetooth	Bluetooth/UDP	UDP/Bluetooth/Type-C
Combo 4	UDP/Type-C	Type-C/UDP	UDP/Bluetooth/Type-C
Combo 5	Bluetooth/Type-C	Type-C/Bluetooth	UDP/Serial/Bluetooth/Type-C

## 6.4 CRC16 Verification code

```

const uint16_t crc16_tab[256];
/*****
CRC16 Coding & Decoding G(X) = X^16+X^12+X^5+1
*****/
uint16_t CRC16_cal(uint8_t *ptr, uint32_t len, uint16_t crc_init)
{
    uint16_t crc,   oldcrc16;
    uint8_t  temp;
    crc = crc_init;
    while (len--!=0)
    {
        temp=(crc>>8)&0xff;
        oldcrc16=crc16_tab[*ptr^temp];
        crc=(crc<<8)^oldcrc16;
        ptr++;
    }
    //crc=~crc;    //??
    return(crc);
}

uint8_t crc_check_16bytes(uint8_t* pbuf, uint32_t len, uint32_t* p_result)
{
    uint16_t crc_result = 0;
    crc_result= CRC16_cal(pbuf,len, 0);
    *p_result = crc_result;

    return 2;
}

```

```

const uint16_t crc16_tab[256]= {0x0,0x1021,0x2042,0x3063,0x4084,0x50a5,0x60c6,0x70e7,

```

# SIYI

0x8108,0x9129,0xa14a,0xb16b,0xc18c,0xd1ad,0xe1ce,0xf1ef,  
0x1231,0x210,0x3273,0x2252,0x52b5,0x4294,0x72f7,0x62d6,  
0x9339,0x8318,0xb37b,0xa35a,0xd3bd,0xc39c,0xf3ff,0xe3de,  
0x2462,0x3443,0x420,0x1401,0x64e6,0x74c7,0x44a4,0x5485,  
0xa56a,0xb54b,0x8528,0x9509,0xe5ee,0xf5cf,0xc5ac,0xd58d,  
0x3653,0x2672,0x1611,0x630,0x76d7,0x66f6,0x5695,0x46b4,  
0xb75b,0xa77a,0x9719,0x8738,0xf7df,0xe7fe,0xd79d,0xc7bc,  
0x48c4,0x58e5,0x6886,0x78a7,0x840,0x1861,0x2802,0x3823,  
0xc9cc,0xd9ed,0xe98e,0xf9af,0x8948,0x9969,0xa90a,0xb92b,  
0x5af5,0x4ad4,0x7ab7,0x6a96,0x1a71,0xa50,0x3a33,0x2a12,  
0xdbfd,0xcbdc,0xfbbf,0xeb9e,0x9b79,0x8b58,0xbb3b,0xab1a,  
0x6ca6,0x7c87,0x4ce4,0x5cc5,0x2c22,0x3c03,0xc60,0x1c41,  
0xedae,0xfd8f,0xcdec,0xddcd,0xad2a,0xbd0b,0x8d68,0x9d49,  
0x7e97,0x6eb6,0x5ed5,0x4ef4,0x3e13,0x2e32,0x1e51,0xe70,  
0xff9f,0xefbe,0xdfdd,0xcffc,0xbf1b,0xaf3a,0x9f59,0x8f78,  
0x9188,0x81a9,0xb1ca,0xa1eb,0xd10c,0xc12d,0xf14e,0xe16f,  
0x1080,0xa1,0x30c2,0x20e3,0x5004,0x4025,0x7046,0x6067,  
0x83b9,0x9398,0xa3fb,0xb3da,0xc33d,0xd31c,0xe37f,0xf35e,  
0x2b1,0x1290,0x22f3,0x32d2,0x4235,0x5214,0x6277,0x7256,  
0xb5ea,0xa5cb,0x95a8,0x8589,0xf56e,0xe54f,0xd52c,0xc50d,  
0x34e2,0x24c3,0x14a0,0x481,0x7466,0x6447,0x5424,0x4405,  
0xa7db,0xb7fa,0x8799,0x97b8,0xe75f,0xf77e,0xc71d,0xd73c,

# SIYI

```
0x26d3,0x36f2,0x691,0x16b0,0x6657,0x7676,0x4615,0x5634,  
0xd94c,0xc96d,0xf90e,0xe92f,0x99c8,0x89e9,0xb98a,0xa9ab,  
0x5844,0x4865,0x7806,0x6827,0x18c0,0x8e1,0x3882,0x28a3,  
0xcb7d,0xdb5c,0xeb3f,0xfb1e,0x8bf9,0x9bd8,0xabbb,0xbb9a,  
0x4a75,0x5a54,0x6a37,0x7a16,0xaf1,0x1ad0,0x2ab3,0x3a92,  
0xfd2e,0xed0f,0xdd6c,0xcd4d,0xbdaa,0xad8b,0x9de8,0x8dc9,  
0x7c26,0x6c07,0x5c64,0x4c45,0x3ca2,0x2c83,0x1ce0,0xcc1,  
0xef1f,0xff3e,0xcf5d,0xdf7c,0xaf9b,0xbfba,0x8fd9,0x9ff8,  
0x6e17,0x7e36,0x4e55,0x5e74,0x2e93,0x3eb2,0xed1,0x1ef0  
};
```

## Chapter 7 Android System

### 7.1 Application Download

The handheld ground station comes pre-installed with the following applications:

- UniGCS
- SIYI QGroundControl
- Ping Tools

If you need to update or re-download these applications, please visit the related product pages on the Siying Technology official website ([www.siyi.biz](http://www.siyi.biz)).

# SIYI

## 7.2 How to Import and Install Applications

### 7.2.1 Import and Install via TF Card

Save the application installation files to a TF card, insert the TF card into the TF card slot at the bottom of the handheld ground station, copy the installation files to the Android system's storage, then use the Android file manager to locate and install the copied files.

### 7.2.2 Import and Install via USB Drive

Save the application installation files to a USB drive, insert the USB drive into the USB-A port at the top of the handheld ground station, copy the installation files to the Android system's storage, then use the Android file manager to locate and install the copied files.



#### Note

Please keep your handheld ground station's Android system as streamlined as possible and avoid installing too many unrelated applications to prevent interference with normal operations.

### 7.2.3 Import and Install via Type-C File Transfer

The ground station can connect directly to a Windows computer through the Type-C port using the file transfer function.

# SIYI

## Steps

1. Connect the ground station to the Windows computer via the Type-C port.
2. Click “OK” to “Close video display and enable Type-C file transfer.”

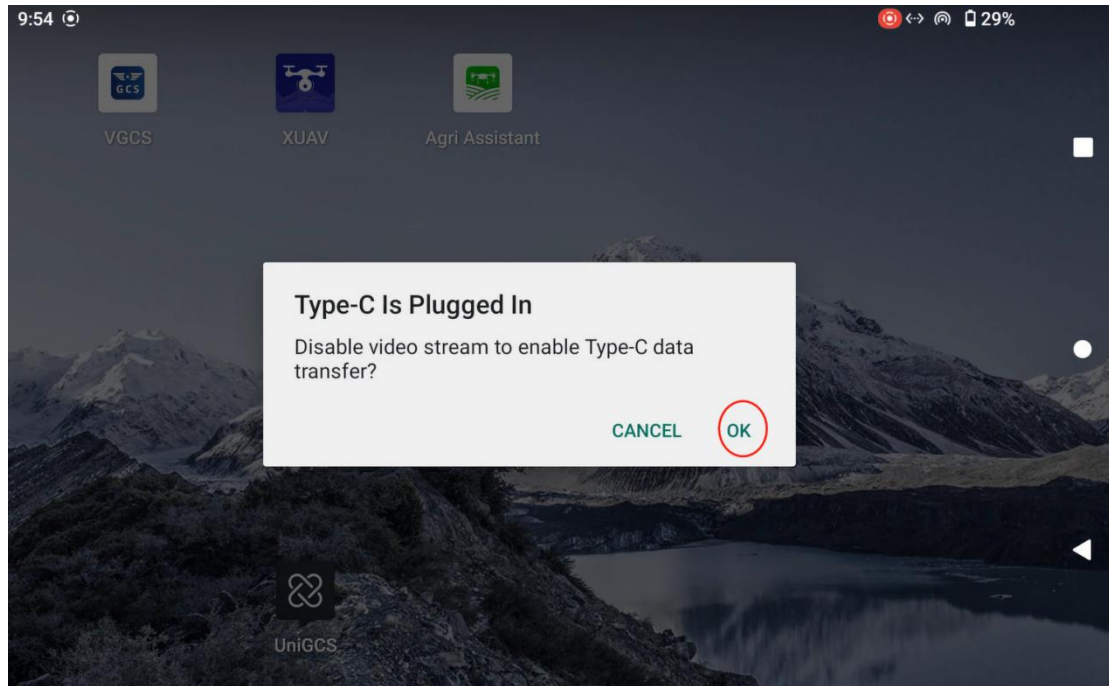

3. In the Android system's dropdown menu, tap “Android system · Charging this device via USB.”

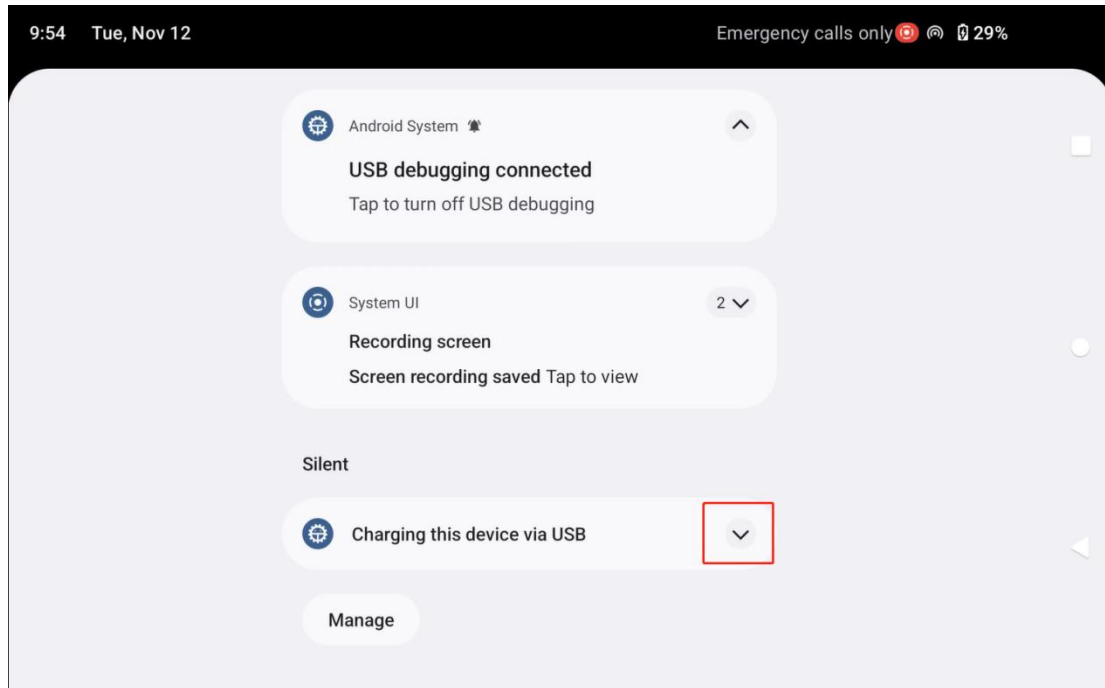

4. Then tap “Charging this device via USB, tap for more options.”

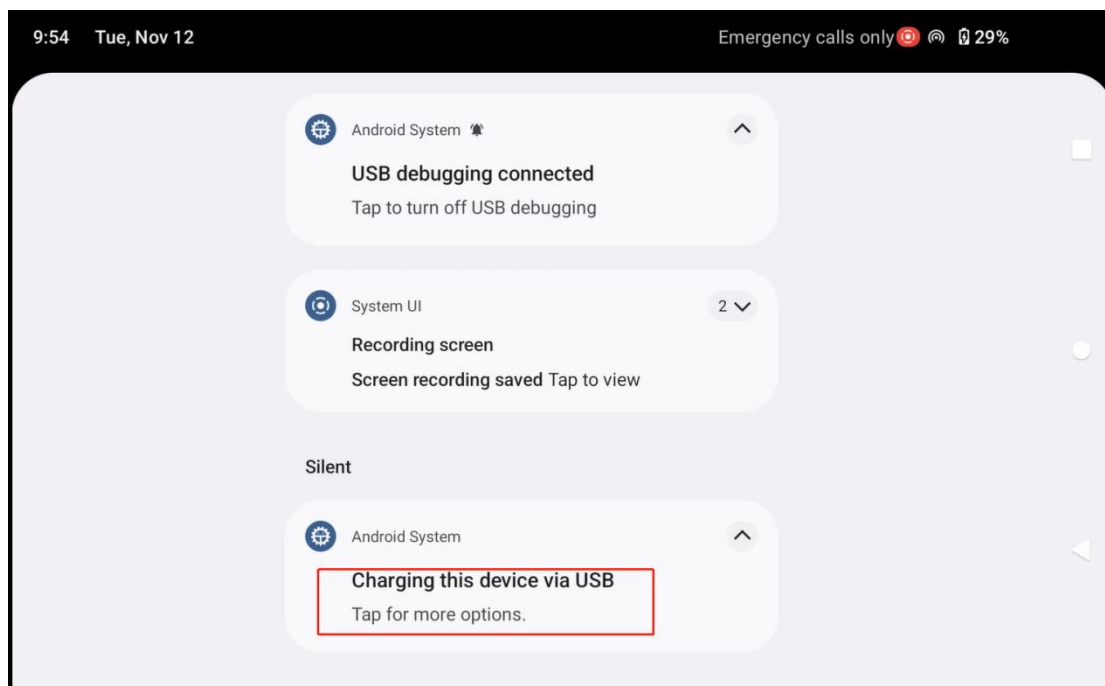

# SIYI

## 5. Select “File Transfer.”

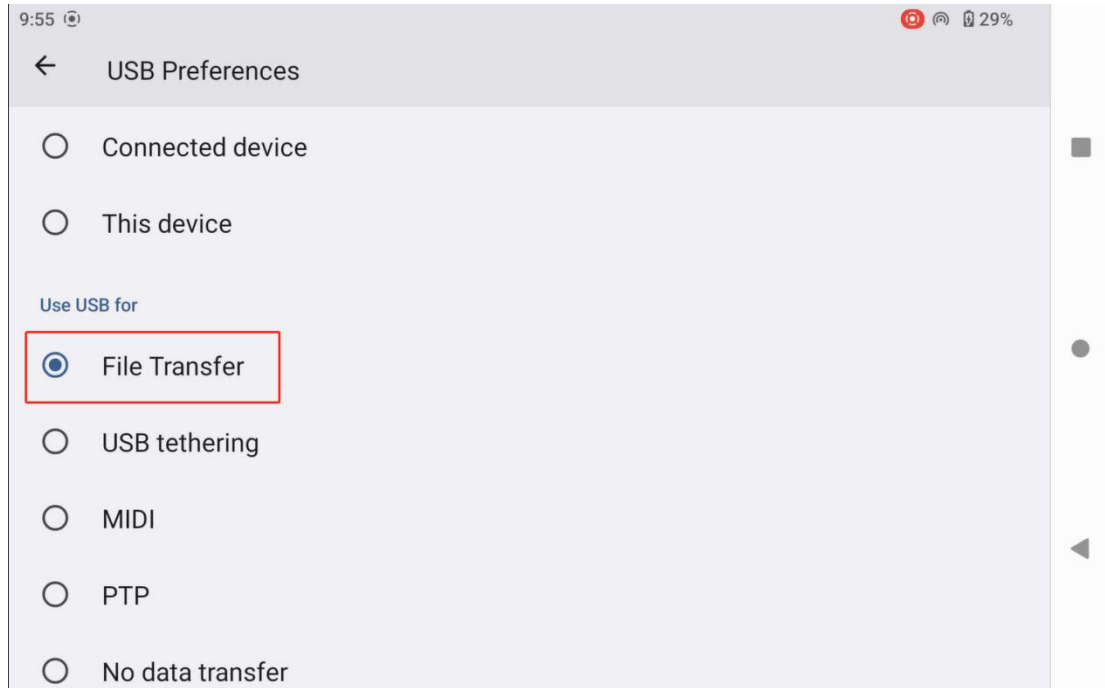

6. At this point, the ground station will be recognized by the Windows computer as a storage device.

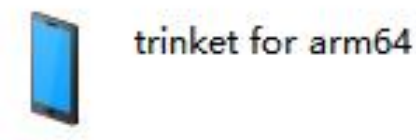

## 7.3 Check Android Firmware Version

The SIYI handheld ground station is equipped with a dedicated Android system.

# SIYI

## Steps

1. Enter the Android system settings menu.

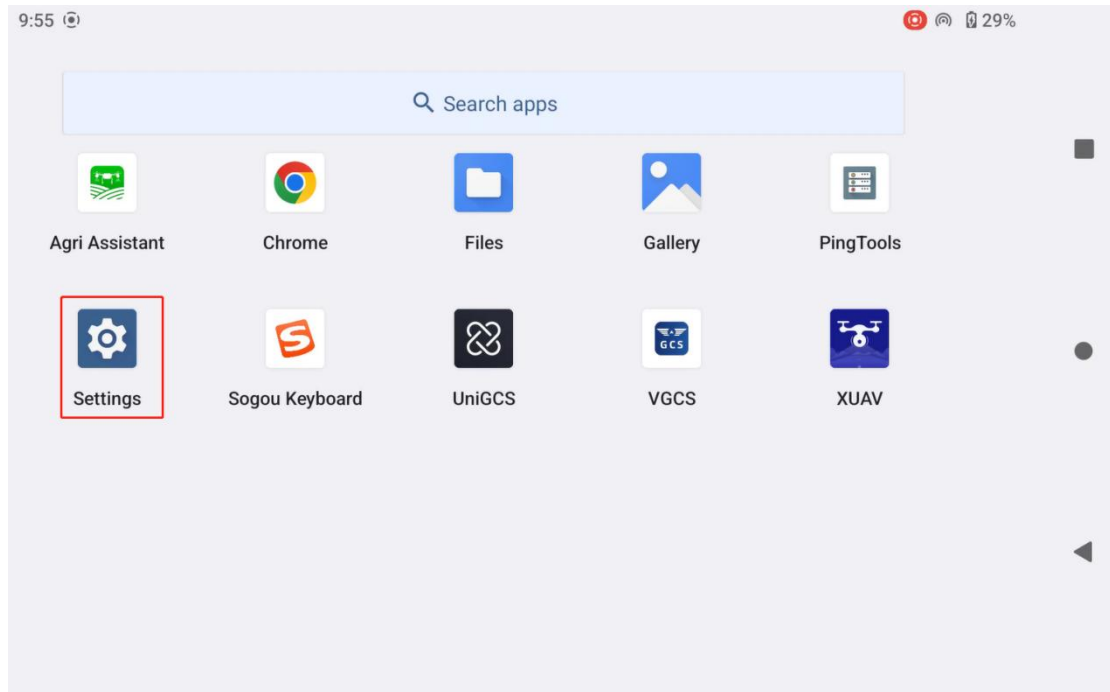

2. Scroll down the page to find and enter the "About phone" menu.

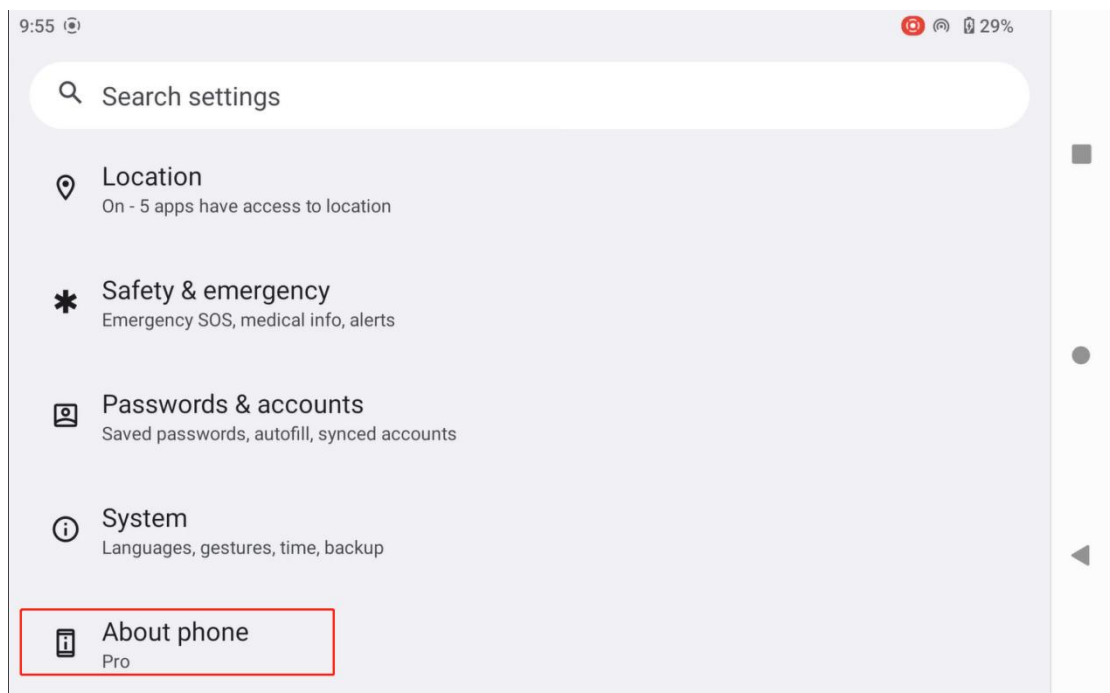

# SIYI

3. Scroll down to the very bottom to view the Android firmware version number.

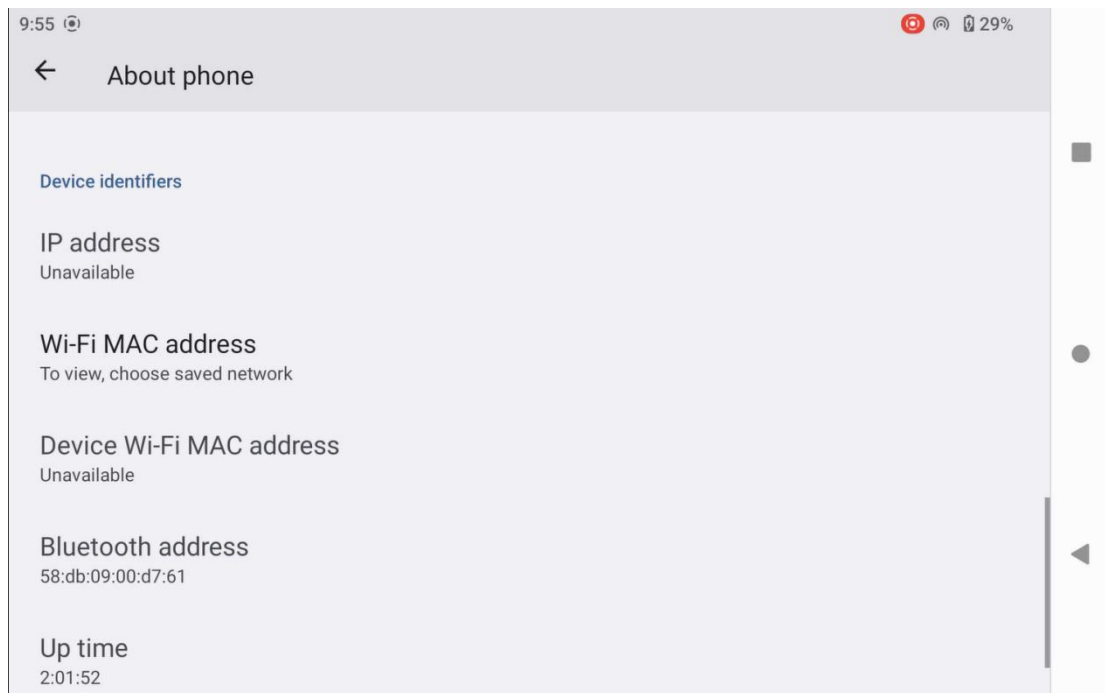

## Chapter 8 SIYI Tuning Assistant

The "SIYI Tuning Assistant" is a Windows software independently developed by SIYI Technology to support almost all SIYI products for channel settings, firmware upgrades, camera tuning, gimbal calibration, and other functions.

### Note:

This manual is based on "SIYI Tuning Assistant" version 1.3.9.

Both the "SIYI Tuning Assistant" and firmware packages can be downloaded from the official website:

# SIYI

<https://siyi.biz/index.php?id=downloads1&asd=191>

## 8.1 Firmware Upgrade

The Ground unit air unit support connection to the "SIYI Tuning Assistant" for firmware upgrades.

Before upgrading the firmware, it is necessary to prepare the following tools, firmware, and software:

- siyi assistant (v1.3.9 or newer)
- Ground Station firmware
- Air Unit firmware

### **Note:**

The above tools and firmware are available on the SIYI official website product pages.

- Fast charging data cable (Type-C to Type-C)
- Adapter (Type-C to USB)

### **Note:**

These tools are included as standard with the product shipment.

The fast charging data cable connected with the adapter can be used for sky station firmware upgrades.

# SIYI

## Firmware upgrade steps:

1. Install the "SIYI Tuning Assistant" on your Windows device.
2. After installation, connect the USB port of the Windows device to the upgrade port at the bottom of the ground station.

### Note:

Please do not click on any pop-up prompts on the screen after the connection is completed.

3. Open the "SIYI Tuning Assistant," switch to the "Upload" menu to check the current firmware versions and corresponding Boot program versions of the ground station and sky station.



	Hardware ID	SM	Boot program	Firmware	Upgrade
主控	9401106880	46453434 00000000	0.1.2	1.2.6	<input type="text" value="getfilename"/> <input type="button" value="upgrade"/>
xt	receiver	00000000 00000000	0.0.0	1.1.6	<input type="text" value="getfilename"/> <input type="button" value="upgrade"/>



4. If the firmware is not the latest, click "Select File" under the "Remote Controller" menu to import the latest ground station firmware, then click "Upgrade." Wait for the upgrade process to reach 100% completion.

# SIYI

5. Disconnect the ground station from the Windows device. Use the fast charging data cable and USB adapter to connect the sky station to the Windows device. Then repeat the above steps to upgrade the sky station firmware.



## Note:

After connecting the ground unit to the computer, if no upgradeable module information appears on the upgrade page, please check whether the green indicator light in the lower left corner of the SIYI Tuning Assistant is lit. If it is not lit, inspect the connection between the device and the computer.

If the green indicator light in the lower left corner is lit, but no upgradeable module information appears on the upgrade page, please follow the steps below to check the settings in the UniGCS:

1. Ensure that the SIYI Tuning Assistant is the latest version. The latest version can be downloaded from the official website's download page.
2. Navigate to the Remote Control Settings page - Data Link Settings, and ensure that the connection methods for Data Link 1 and Data Link 2 are not set to "Upgrade" mode.
3. Then, go to the Remote Control Settings page - System Settings, and make sure the Remote Control SDK connection method is not set to "Upgrade" mode.

## 8.2 Image Transmission Firmware Upgrade

1. Before upgrading the image transmission firmware, please save the firmware to be upgraded in the root directory of the remote controller.
2. Refer to Section 3.3.11 to enter the image transmission firmware selection page.
3. Select the image transmission firmware to be upgraded from the internal storage.

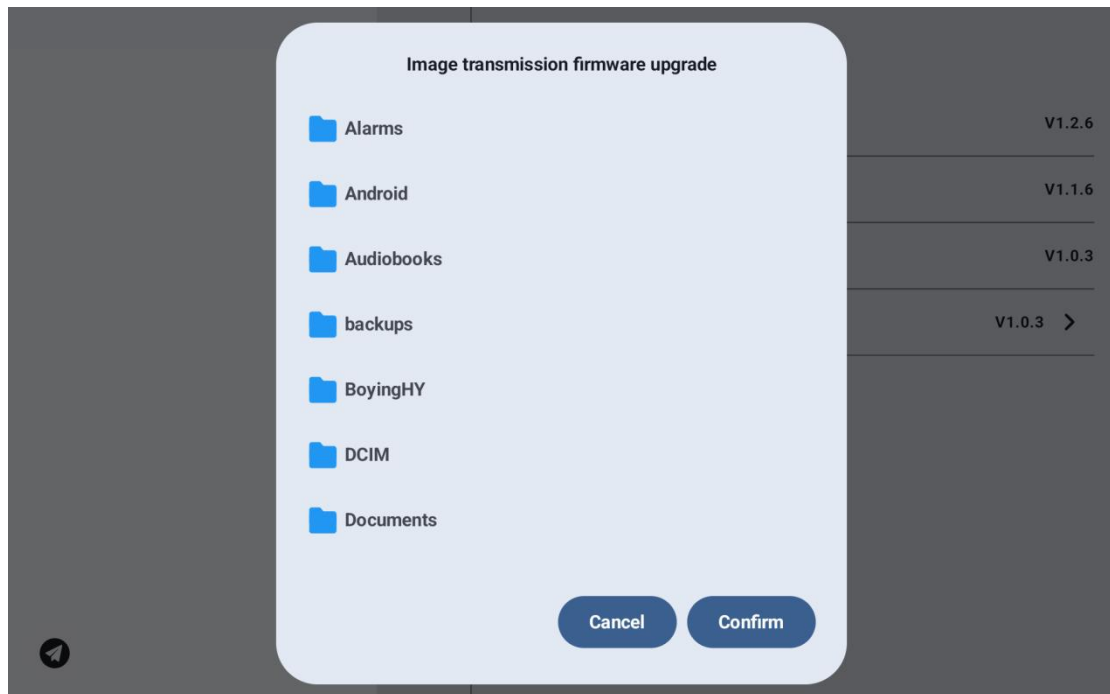

4. Click "Confirm" and wait for the upgrade to complete.

### Note:

Before updating, please first check the video transmission firmware version prefix in the Device Information section of UniGCS:

- If the prefix is CX6653C-N, select the corresponding ZIP file for CX6653C-N in the video transmission firmware folder for the upgrade.

# SIYI

- If the prefix is 7-VTS-H, select the corresponding ZIP file for 7-VTS-H in the video transmission firmware folder for the upgrade.

# SIYI

## Chapter 9 After Sales and Warranty

Please visit the SIYI Technology support page at [Service and Support - SIYI Technology | Empowering and Building an Intelligent Robot Ecology](#) for the latest after-sales and warranty information.